

MOTORCYCLE OPERATOR MANUAL

Two- and Three-Wheel

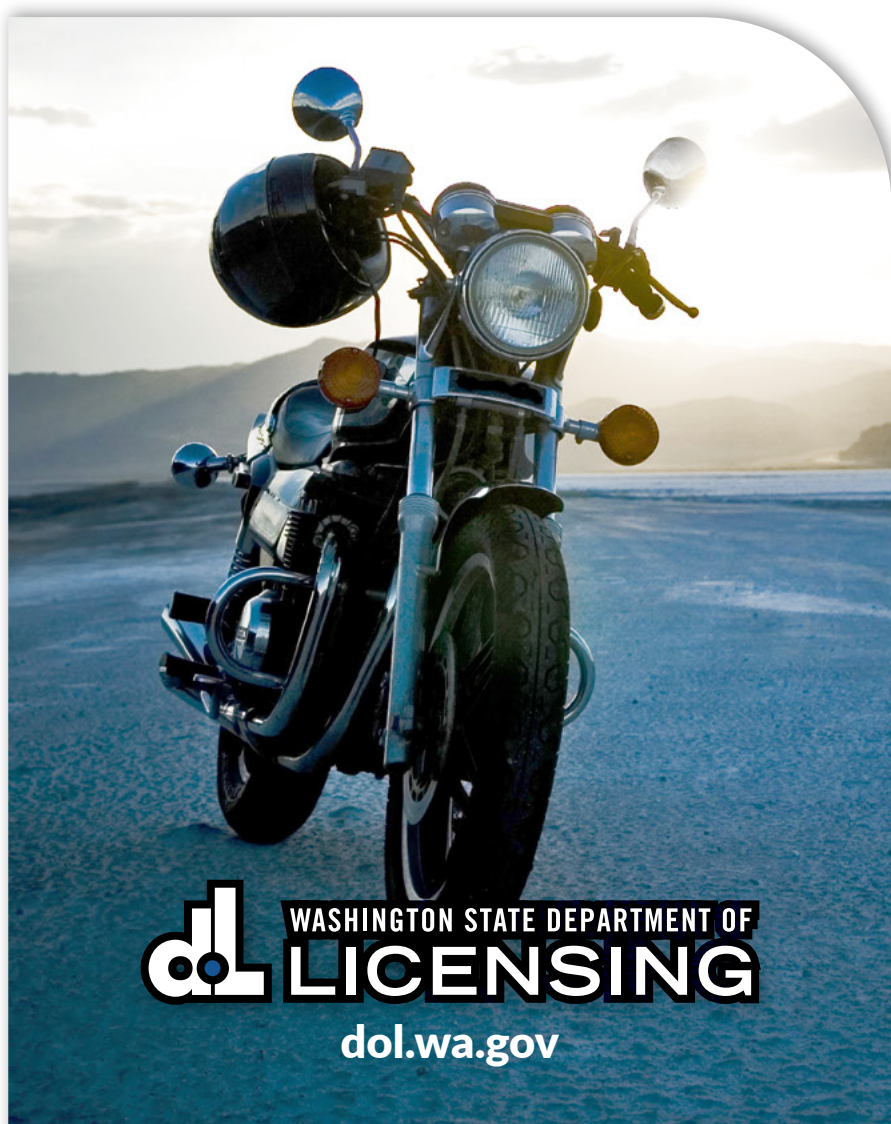

 WASHINGTON STATE DEPARTMENT OF
LICENSING

dol.wa.gov



TRAINING for LIFE

Get More From Your Ride



To find out why, check out our videos at
<http://www.dol.wa.gov/driverslicense/motorcycles.html>

 WASHINGTON STATE DEPARTMENT OF
LICENSING

520-407 (R/12/19)

CONTENTS

WASHINGTON MOTORCYCLE SAFETY PROGRAM

Two- and Three-Wheel Motorcycle Endorsements	1-1
Obtaining Your Permit/Endorsement	1-2
Endorsement Fees	1-2
Instruction Permits	1-3
Rider Training and Education	1-3
Two-Wheel Rider Education Courses	1-4
Novice Rider Courses	1-4
Intermediate Rider Courses	1-4
Advanced Rider Courses	1-4
Three-Wheel Rider Education Courses	1-5
Novice Three-Wheel Rider Course	1-5
Advanced Three-Wheel Rider Courses	1-5
Endorsement Testing	1-6
Transferring from Out-of-State	1-6
PREPARING TO RIDE	
Create Your Own Safety	2-1
Create Your Own Safety with Functional Gear	2-2
Helmets	2-2
Helmet Types and Construction	2-2
Helmet Fit	2-4
Eye Protection	2-4
Protective Gear	2-5
Jacket and Pants	2-5
Boots and Shoes	2-6
Gloves	2-6
Hearing Protection	2-6
Comfort and Weather Protection	2-6
Visibility	2-7
Understanding and Inspecting Your Motorcycle	2-7
Choosing the Right Motorcycle	2-7
Getting to Know Your Motorcycle	2-8
Checking Your Motorcycle	2-8
Create Your Own Safety by Taking Responsibility	2-10

RIDING A TWO-WHEELED MOTORCYCLE

The Right Bike for You	3-1
Differences between Two- and Three-Wheeled Motorcycles	3-1
Riding Posture	3-1
Basic Controls and Operation	3-2
Clutch Control and Shifting Gears	3-3
Two-Wheel Steering	3-3
Cornering	3-3
Cornering Steps	3-4
Cornering Lines	3-5
Look, Anticipate, Choose	3-7
Braking	3-8
Braking in a Straight Line	3-8
Braking in a Corner	3-8
Evasive Maneuvers	3-9
Quick Stops	3-9
Swerves	3-10
Carrying Passengers and Cargo	3-10

RIDING A THREE-WHEELED MOTORCYCLE

Types of Three-Wheelers: The Right Trike for You	4-1
Differences between Two- and Three-Wheeled Motorcycles	4-1
Advantages	4-2
Disadvantages	4-2
Riding Posture	4-2
Basic Controls and Operation	4-3
Clutch Control and Shifting Gears	4-3
Unique Handling Characteristics	4-4
Three-Wheel Steering	4-4
Tip-Over Lines	4-4
“Flying” and Steering Reversion	4-6
Yaw	4-6
Cornering	4-7
Cornering Steps	4-8
When Turning a Trike	4-9
When Turning a Sidecar Rig	4-9
Hills	4-9

Drifting	4-10
Braking.	4-10
Braking in a Straight Line.	4-10
Braking in a Corner	4-10
Evasive Maneuvers	4-11
Quick Stops	4-11
Swerves	4-12
Carrying Passengers and Cargo	4-12

STRATEGIES FOR THE STREET

Street Strategies	5-1
Seeing and Being Seen	5-1
Lane Choice.	5-1
Lane Position	5-3
Being Visible	5-4
Creating Time and Space	5-5
Total Stopping Distance	5-5
Look Farther Down the Road.	5-6
Following Distance.	5-6
Being Followed	5-6
Proactive Strategy	5-7
Roadway Management Skills	5-7
Intersections.	5-7
Surface Hazards	5-8
Crossing an Obstacle.	5-10
Changing Lanes.	5-10
Passing	5-10
Riding at Night	5-11
Target Fixation	5-12
Group Riding	5-12
Give Each Other Space	5-13
Staggered Formation	5-13
Ride Your Own Ride.	5-13

IMPAIRMENTS

Types of Impairments	6-1
Alcohol and Drugs	6-1
Marijuana	6-3

Alcohol and the Law	6-3
Consequences of Conviction	6-3
Technology	6-4
Body and Emotions	6-4
Peer Pressure	6-5
Riding in Groups	6-6
Own Your Ride.	6-6
Never Stop Training	6-6
Wear the Gear	6-6
Challenge Peer Pressure	6-7
Ride Sober and Undistracted	6-7
Create your own Safety	6-7
Always Ride Within your Skill Level	6-8
Notes	7-1

This guide should not be used as a basis for legal claims or actions. Traffic regulations in cities, towns, and counties may go beyond state laws but cannot conflict with them . If you are interested in specific laws relating to motor vehicle operation, motorcycle operations, and driver licensing, refer to Title 46 RCW, Motor Vehicles. Please read it carefully .

We welcome your written comments or suggestions. Your comments should be addressed to:

Motorcycle Safety Program
Department of Licensing
PO Box 9030
Olympia, WA 98507

You can always find the most recent version of this guide as well as other current information on our website at **www.dol.wa.gov**.

This motorcycle operator's manual includes information provided by National Public Services Research Institute (NPSRI), the National Highway Traffic Safety Administration (NHTSA), the Motorcycle Safety Foundation (MSF), Evergreen Safety Council (ESC), and the American Association of Vehicle Administrators (AAMVA) .

Published by the Washington State Department of Licensing .

We are committed to providing equal access to our services. For more information visit dol.wa.gov/access (TDD/TTY 711).

WASHINGTON MOTORCYCLE SAFETY PROGRAM

This manual is provided by the Washington State Department of Licensing (DOL) and Washington Motorcycle Safety Program (WMSP); it provides motorcycle riding techniques and information for both inexperienced and experienced riders.

Our goal is to foster and promote safe motorcycle riding through:

- Quality rider training programs
- Public information campaigns throughout Washington State
- Permit and endorsement issuance through comprehensive evaluations.

Rider education training courses in Washington are recognized nationally. Training is conducted locally by DOL-approved providers, and subsidized through the use of motorcycle endorsement and renewal fees.

For more information on endorsement and permit fees, motorcycle laws, or to find a motorcycle training/testing provider closest to you, visit: dol.wa.gov.

Two- and Three-Wheel Motorcycle Endorsements

You must have a motorcycle permit or endorsement on your driver license to legally operate a motorcycle on Washington State roadways. State law mandates separate training, testing, and endorsements for two- and three-wheeled motorcycles because of the differences in handling.

To lawfully operate:

- A two-wheeled motorcycle, you must have a two-wheel ("Class 3" endorsement if license issued prior to June 2017) or (Endorsement L with restriction [J — two-wheeled motorcycle only] for license issued after June 2017).
- A three-wheeled motorcycle (sidecar rig, trike, reverse trike, etc.) you must have a three-wheel ("Class 5" endorsement for license issued prior to June 2017) or (Endorsement L with restriction [J — three-wheeled motorcycle only] for license issued after June 2017).

- Both two-wheeled and three-wheeled motorcycles, you must have a combined two-wheel and three-wheel (“Class 7” endorsement for license issued prior to June 2017) or (Endorsement L with restriction [J — two-wheeled & three-wheeled motorcycle] for license issued after June 2017).

Your motorcycle may be impounded if it is operated on public roadways without the required endorsement. The current minimum fine for riding without an endorsement is \$386.

Liability insurance is mandatory for all motorcycles under RCW 46.30.020

Obtaining Your Permit/Endorsement

You must pass both a basic knowledge and skills test to obtain a permit. You are required to take an advanced knowledge and skills exam to get an endorsement.

You can find training/testing providers at: dol.wa.gov/driverslicense/motoschools.html.

Similar to other sports, motorcycling requires specialized physical and mental skill; training and practice are required to develop and maintain these skills. The consequences of not being proficient in this sport are serious injury or even death. Taking additional advanced training to improve your physical and mental riding skills will help you become a safer rider.

Washington State Law requires all riders under 18 years of age to satisfactorily complete an approved rider course before applying for an endorsement. Students under the age of 18 must have parental permission to take a training course and apply for an endorsement.

Endorsement Fees

You can find current motorcycle endorsement fees at: dol.wa.gov/driverslicense/fees.html

Motorcycle endorsement and renewal fees are used to subsidize motorcycle safety training classes, to promote motorcycle safety and awareness throughout Washington State, and for program administration.

Instruction Permits

You must pass a basic knowledge and skills test in order to apply for a 180-day permit to drive on public roadways. Riders must be at least 16 years of age, and possess a current Washington driver license.

Riders with instruction permits are restricted from carrying passengers or riding at night.

Permits expire after 180 days, and may be renewed one time within a 5-year period.

Knowledge tests are conducted by contracted training/testing providers.

Find training/testing providers near you at: dol.wa.gov/driverslicense/mototraining.html

Rider Training and Education

The Washington Motorcycle Safety Program highly encourages you to take both initial and on-going motorcycle training. Riders who do not take official training courses miss out on key teachings such as technique, street strategies, and skill development from professional motorcycle instructors.

The Department of Licensing has approved a variety of novice, intermediate, and advanced two- and three-wheel training courses that are available throughout Washington State. Completion of a motorcycle training course may qualify you for a discount on motorcycle insurance. Make sure you become the best in your sport by learning the essentials, but also pick up tips and tricks from the professionals!

There is a waiting period of three business days after you have completed a training course before you may visit a licensing office to have your permit or endorsement added.

Two-Wheel Rider Education Courses

Novice Rider Courses

A course for new riders with little or no experience, which normally lasts for two or more days.

Novice rider training offers:

- Classroom instruction and approved curriculum materials covering topics such as basic motorcycle operation, riding techniques, street strategies, and protective gear
- Use of a training motorcycle for the class, or you may use your own*
- Hands-on riding instruction in a protected training area
- Knowledge and skills permit tests as a part of the course

* Your motorcycle must pass a pre-ride inspection, and you must provide proof of insurance when using your personal motorcycle.

Intermediate Rider Courses

This course is designed for returning riders, or riders with basic motorcycle knowledge. Intermediate training is usually a one-day course, and offers:

- Tailored classroom instruction and approved curriculum materials covering topics such as riding techniques, street strategies, and protective gear
- Use of a motorcycle for the class, or you may use your own*
- Hands-on riding instruction in a protected training area
- Knowledge and skills permit tests as a part of the course

* Your motorcycle must pass a pre-ride inspection, and you must provide proof of insurance when using your personal motorcycle.

Advanced Rider Courses

Advanced rider courses are designed for experienced riders and will give you an opportunity to increase your skills on your own motorcycle.*

These courses may offer:

- Riding practice that includes advanced braking, cornering, and swerving
- Discussion of advanced techniques and defensive street strategies
- Students provide their own motorcycles for this course.
- Endorsement test may be taken with this course

*You must show proof of insurance, and your motorcycle must pass a pre-ride inspection.

Three-Wheel Rider Education Courses

Novice Three-Wheel Rider Course

Basic three-wheel courses are designed for riders with little or no experience on three-wheelers. The course offers:

- Classroom instruction and approved curriculum materials covering topics such as basic three-wheel operation, riding techniques, street strategies, and protective gear
- Some locations provide the use of a three-wheeler, or students may use their own three-wheeler*
- Hands-on riding instruction in a protected training area
- Knowledge and skills endorsement test as a part of the course.

* Your motorcycle must pass a pre-ride inspection, and you must provide proof of insurance when using your personal motorcycle.

Advanced Three-Wheel Rider Courses

This course is designed for those with basic and intermediate three-wheel riding experience and may offer:

- Advanced classroom instruction and approved curriculum materials covering topics such as riding techniques, street strategies, and protective gear
- Hands-on riding instruction in a protected area

- Knowledge and skills endorsement test as a part of the course
- Students provide their own three-wheelers for this course. You must show proof of insurance, and your rig must pass a pre-ride inspection.

Endorsement Testing

Both two- and three-wheel motorcycle knowledge and skills tests are given by DOL-contracted training schools throughout the state. You do not have to take training in order to take the permit or endorsement tests.

There will be a waiting period of three business days after you have completed the required exams before you may visit a licensing office to have your endorsement added.

Please visit our website for more details and DOL-approved training school/testing providers:

dol.wa.gov/driverslicense/mototraining.html

Transferring from Out-of-State

When transferring your out-of-state driver license with a current and valid motorcycle endorsement to Washington, you must let DOL staff know that you also want to transfer the endorsement.

If you want a two-wheel endorsement when transferring from out of state, you must present:

- A current and valid two-wheel motorcycle endorsement

If you want a three-wheel endorsement when transferring from out of state, you must present:

- A current and valid three-wheel motorcycle endorsement*

* Documentation provided must show that you passed a separate and distinct three-wheel test in the state from which you are transferring. If there is no proof of a separate and distinct three-wheel test, you will only be offered a two-wheel endorsement.

Please visit our website for more details and DOL driver licensing service office locations: <https://fortress.wa.gov/dol/dolprod/dsoffices/>

PREPARING TO RIDE

Create Your Own Safety

Like the choice to drive, the choice to ride carries with it a certain amount of risk. However, motorcycle riders face risk in different and more significant ways: traction, weather, and potential road hazards all pose considerable challenges to riders that drivers don't often face.

Adding to these increased risks are factors related to:

- **Protection** – lack of protection that is built into vehicles: no seat belts, air bags, or steel roll cages
- **Stability** – difference in stability and balance (four wheels vs. three or only two)
- **Traction** – two wheels are much more affected by surface hazards than four
- **Comfort** – riders are more exposed to elements than drivers are
- **Visibility** – motorcycles are much harder to see than cars.

The majority of motorcycle crashes involve several risk factors stacking up at one time. As an example, think of a tower of blocks being stacked on end. Each block represents a different risk that a rider must be aware of and learn to manage. If the tower is stacked too high, it falls. The same can be true when riding—too many risks stacked up eventually cause a fall. The constant development and practice of physical and mental riding skills can help you reduce or eliminate many risks when riding.

Does choosing to ride a motorcycle increase your risk compared to driving a car? Yes. Riding is different from driving in that you must think like a rider instead of like a driver. You must increase awareness of your environment and how your vehicle handles, all while responding proactively to hazards.

Are there ways that you can actively manage these risks? You can manage some of these risks by preparing for every single ride. Is your body protected? Is your bike ready? Are YOU ready?

Remember that your own skill and behavior is the greatest risk to you as a motorcyclist. Recognize, accept, and manage your risks.

Create Your Own Safety with Functional Gear

One way to manage risk is to choose gear that offers:

- **Protection** – from both abrasion and impact
- **Comfort** – to keep you focused on the road
- **Visibility** – to help other road users see you

Protective gear can significantly reduce risk by providing protection in a crash, comfort in varying weather conditions, and visibility so others on the road can see you.

Helmets

The most common cause of rider death in motorcycle crashes is head injury. Regardless of speed, helmeted riders are much more likely to survive a head injury in a crash than those riders not wearing a helmet. The single most important thing you can do to reduce risk and improve your chances of surviving a crash is to wear a quality, properly fitted, and securely fastened helmet.

To legally ride in Washington you are required to wear a helmet that is compliant with Department of Transportation (DOT) guidelines. DOT compliance is indicated by “DOT” labels on the rear exterior, as well as interior of the helmet.

Novelty helmets are not DOT compliant, and may not be worn on public roadways when riding a two- or three-wheeled motorcycle.

Helmet Types and Construction

Helmets come in a variety of styles (Figure 2-1), including full-face (A), modular or flip-up (B), three-quarter shell (C), and half shell (D). Half-shell and three-quarter shell helmets do not provide protection for your chin and face in a crash. Full-face helmets are considered the safest helmet, as they provide the best protection for these areas.

Regardless of style, DOT-compliant helmets are required to have:

- An impact-resistant outer shell
- An impact-absorbing inner liner (usually of Expanded Polystyrene [EPS] foam)

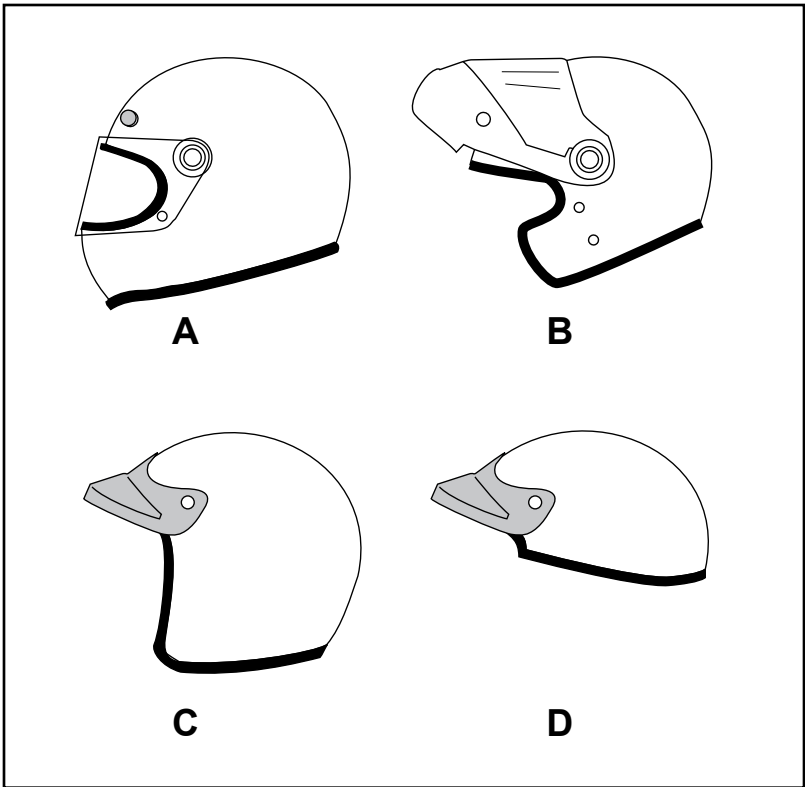

Figure 2-1
Types of helmets

- A comfort liner (the padding)
- A neck- or chin-strap type of retention system

A helmet should be replaced if it has obvious defects such as cracks or frayed straps, and after being involved in a crash. Many manufacturers recommend you replace a helmet every five years due to the breakdown of protective materials over time.

In addition to DOT compliance, helmets may have other safety certifications. The most common of these are Snell (from the Snell Memorial Foundation) and ECE (Economic Commission for Europe). You should research different helmet styles and certifications to help determine which helmet is best for you. Remember, all helmets legally allowed in Washington must be at least DOT compliant.

Another consideration when choosing a helmet is how it can help you be more visible to other road users. Being visible is an important part of reducing risk, so think about switching from a dark-colored helmet to a brightly-colored, or white helmet.

Helmet Fit

Apart from styles and certifications, one of the most important factors of a helmet's ability to protect you is how it fits. A helmet should fit snugly all the way around: It should not be so tight that it causes pain or headaches, and should not be so loose that it moves around on, or lifts off of your head while riding.

Helmet manufacturers make helmets for different head shapes; research different brands to help you determine the best fit.

Properly fitted DOT-compliant helmets will not block or obstruct a rider's central or peripheral vision. Properly fitted helmets do not obstruct sounds that motorcyclists need to hear. Be safe and always wear a quality, properly fitted, DOT-compliant helmet that offers the most protection, comfort, and visibility.

Eye Protection

Washington law requires wearing eye protection when riding on public roadways, unless your motorcycle is equipped with a windshield. Goggles may also be used to protect your eyes, but wearing goggles, or even using a windshield may not protect against environmental elements or road debris.

Eyeglasses or sunglasses typically don't provide enough protection either, as most are not shatter resistant, and they may come off when turning your head at highway speeds.

A helmet with a plastic, shatter-resistant face shield not only offers the most protection for your eyes, but can also help protect your face in a crash. All of the previously mentioned problems are distracting and painful, but can become deadly if you are unable to concentrate on the road because your vision has been compromised.

To be effective, eye or face shield protection must:

- Be free of scratches
- Be resistant to penetration

- Give a clear view to the front and either side
- Fasten securely to the helmet so it does not blow off
- Permit air to pass through to reduce fogging
- Permit enough room for eyeglasses or sunglasses, if needed

Tinted eye protection should not be worn during low-visibility conditions such as dusk, or when riding in poor weather conditions such as fog or rain.

Protective Gear

The minimum protective gear required to ride legally in Washington State is a DOT-approved helmet and eye protection--but think about whether this would suffice to protect your body in a serious crash. Should you wear the most protective gear possible at all times? The answer is YES.

Jacket and Pants

Motorcycle protective gear is typically designed to fit differently than street clothing. Many riding jackets have sleeves that are cut longer, and extend lower on your back; this improves the fit when a rider leans forward to reach the handlebars. The gear should fit snugly, yet loosely enough to allow you to move freely.

Motorcycle gear made of leather or sturdy abrasion-resistant material offers the best protection--denim does not provide significant abrasion protection. To protect against impact, you should choose gear with body armor inserts in critical areas such as knees, elbows, shoulders, hips, and back.

Wearing a jacket and pants designed for motorcycle riding can help you feel comfortable and less distracted in varying weather conditions. In cold weather, proper gear can help prevent hypothermia, which is when your body temperature becomes too low. Hypothermia is dangerous because it can cause loss of physical and mental function.

A riding jacket and pants can help protect against the effects of heat exhaustion and dehydration in hot weather. Try to find gear with vents and/or mesh panels that protects against direct sunlight and wind, but also allows airflow to help keep you cool. The more comfortable you are, the better you can focus on riding safely.

Boots and Shoes

Riding boots or shoes designed for motorcycle use should be sturdy, but also high enough to cover your ankles. Proper riding footwear should feature reinforced areas in the ankle, shin, toe and heel for additional support and protection. Riders should wear footwear with soles made of hard, durable, slip-resistant material. Remember to keep heels short, so they do not catch on rough surfaces, but also so they fit within foot pegs and controls. Laces should be tucked in to prevent them from catching on parts of the bike.

Gloves

A natural instinct when falling is to put our hands out in front of us; although this may not always be the correct way to fall, it poses a risk of injury to your hands. Riding gloves are usually made of leather or textile, and often include added protection such as padding and rigid armor in potential impact areas. Try many different pairs of gloves and make sure that they fit snugly, but do not restrict movement; make sure there are no seams that will cause pain to the fingers or hands. Motorcycle-specific gloves should fit properly to offer good grip and control while providing protection for your hands and fingers.

Hearing Protection

Even with a full face helmet, noise from your bike, but especially from the air flow around your helmet, can be significant. Long term exposure to wind and road noise can cause permanent hearing damage.

Good hearing protection reduces the level of harmful noise, while still allowing you to hear important sounds such as horns and sirens. No matter what brand or style of helmet you choose, also select additional hearing protection to reduce the risk of hearing loss.

Note: The use of in-ear hearing protection (ear plugs) is legal in Washington, but in-ear speakers (ear buds) are not.

Comfort and Weather Protection

You should be aware of environmental conditions and dress accordingly. How well does your gear help you stay comfortable and alert in the conditions you may encounter on your ride? Many

riders wear multiple layers as a way to be ready for varying weather conditions.

Riding a motorcycle in moderately cold temperatures can lead to severe chill, fatigue, or even hypothermia. In contrast, riding in extreme heat can cause sun stroke, sunburn, dehydration, and fatigue. Choose gear to help reduce environmental risks: if you are distracted by weather conditions it reduces your ability to concentrate on riding safely.

Visibility

One of the most common statements from car drivers after being involved in a crash with a motorcycle is, “I didn’t see the motorcycle.” It is typically more difficult to see motorcycles since they are smaller in profile, and also have smaller lights. As a rider, you own the responsibility to be seen. One of the best ways to reduce risk is to choose riding gear that allows you to see and be seen. Assume that other drivers can’t see you, and help them by wearing brightly-colored and reflective gear. If you prefer to wear black gear, you should choose to wear a high-visibility reflective vest over your jacket for the duration of your ride.

Understanding and Inspecting Your Motorcycle

Statistics show that a majority of crashes occur when a rider has less than six months of experience on their current motorcycle, regardless of experience level.

You can reduce your risk of a crash by:

- Choosing the appropriate size and type of motorcycle for your skill level
- Familiarizing yourself with the controls, performance, and handling capabilities of your motorcycle
- Conducting pre-ride inspections of your bike and keeping up to date with maintenance

Choosing the Right Motorcycle

Select a bike that both fits you and the type of riding you plan to do. Two- and three-wheeled motorcycles come in a wide variety of sizes and styles, and not all motorcycles fit all purposes:

a heavyweight cruiser may not be the best for off-road riding; a small dual-sport bike might not have the luggage capacity needed for a multiple-day tour; a sport bike is not as comfortable for passengers as a sidecar, for instance.

Try sitting on the motorcycle you plan on purchasing, and ask yourself the following questions:

- Can you comfortably reach all the controls?
- Is the size, weight, and power suitable for your comfort and experience level?
- Does the style suit your needs?

New riders should start out on bikes that are smaller and lighter in weight because they can be easier to control, less intimidating, and easier to maneuver.

Consider how you want to use your bike: will you use it for recreation, touring, cruising around town, or commuting?

Motorcycles come in designs and styles suited for many different uses. Whether a dual-sport, cruiser, standard, sport bike, trike, or sidecar equipped motorcycle — choosing a bike designed for your preferred type of riding and skill level can decrease your risk, and increase your enjoyment of the road.

Getting to Know Your Motorcycle

Once you have brought your motorcycle home, or even if you are borrowing one, spend some time getting to know it. Become familiar with the controls and how to use them; using unfamiliar controls can be a big distraction, and distracted riding can lead to a crash.

Each two or three-wheeled motorcycle has its own unique handling personality. Be especially careful on any motorcycle that is unfamiliar to you, no matter how experienced you are.

Find an empty, safe area in which to practice locating and using your controls. Practice slow speed maneuvers, turns, stops, and swerves. Take an advanced training course to increase your skills and familiarity with your new bike.

Checking Your Motorcycle

The primary source of information about your bike, including specifications, operation, and suggested maintenance is in

the owner's manual; make sure to read and understand it. A motorcycle will continue to ride like new if properly maintained.

A motorcycle needs more frequent attention than a car. A minor technical failure on a car is seldom more than an inconvenience for the driver; the same on a motorcycle may result in a breakdown, or even worse: a crash. Make sure to know if anything is wrong with your motorcycle before you head out on the road.

To stay aware of your motorcycle's current mechanical condition, conduct pre-ride inspections of your bike. A pre-ride inspection is a quick and easy check of critical components and only takes a few minutes. Inspections of your bike should be as routine as checking the weather forecast before heading out for a ride.

A convenient checklist for pre-ride inspection consists of the following:

T – Tires and Wheels

- Air pressure
- Tread
- Cracked sidewalls, dented wheels, loose spokes

O – Oil and Other Fluids

Levels

Leaks

L – Levers and Controls

Levers and pedals

Cables

Hoses

Throttle

L – Lights

Headlight

Taillights and brake lights

Turn signals

Switches

S – Suspension and Drivetrain

Suspension

Chain, belt, or drive shaft

S – Stands

Kickstand

Center stand (if equipped)

*For sidecar equipped motorcycles: make sure that the connections between sidecar and motorcycle are secure and that the sidecar brake (if so equipped) is operational.

Additionally, regular maintenance such as tune-ups and oil changes are as important for a motorcycle as routine checkups by your doctor are for you. Wear and tear is normal with every mile you ride.

Pre-ride inspections and routine maintenance can help prevent costly breakdowns.

Create Your Own Safety by Taking Responsibility

Riding a motorcycle requires mental focus, situational awareness, and physical ability—regardless of whether you are riding on two or three wheels. You are the only person who is responsible for the risk you take when you ride. You are responsible to protect your body from risk by wearing as much effective safety gear as you possibly can. You are responsible for the maintenance and pre-ride inspections of your bike.

You are responsible for assessing and adjusting your psychological attitude before every single ride.

You are also responsible for identifying your experience and skill levels, making sure to ride within your limits—always be aware of peer pressure situations, and resist the urge to show off.

Sometimes being a good rider is recognizing when NOT to ride: you increase your risk significantly when you ride while you are angry, ill, or tired.

You are always responsible for your actions and the outcome of your chosen actions. For example: you are waiting at a red light to turn in an intersection: you move forward without checking traffic as the light turns green. Another vehicle runs a red light and hits you—the driver should have stopped, but it was your responsibility to look before pulling into the intersection. Bear in mind that though the other driver may be legally at fault, you own some of the responsibility in any crash. Always think of how you can avoid a crash at any given moment: do you have enough space cushion? Have you calculated an escape route? Can you see and be seen? You are always more vulnerable to injury in a crash than a car driver, no matter who is at fault; make sure you do all you can to take responsibility for your own safety.

Always ride as though you are invisible. Part of riding defensively is assuming that other road users cannot see you. Try to reduce your chances of a crash occurring by:

- **Being visible** – wear bright, reflective clothing; use your headlight and ride in the best lane position in which to see and be seen.

- **Communicating Intentions** – use your signals, brake light and hand signals when necessary.
- **Creating Space** – Maintain an adequate space cushion when passing, following, or being followed; this way you will also have more time to react to hazards.
- **Actively Searching** – Continually search your path of travel as far ahead as possible to anticipate any potential hazards.
- **Identifying and Evaluating** – assess all potential hazards and ask yourself, “What if?”
- **Being Prepared** – always remain alert and ready to use crash-avoidance skills, but also have an escape plan.

You will notice a difference in your confidence and safety levels as you continue applying the skills you learn in a training course. Training courses give you the tools to be able to create your own safety—it is up to you to apply them.

RIDING A TWO-WHEELED MOTORCYCLE

The Right Bike for You

When choosing a motorcycle, think about how you plan to use it, then choose a type of motorcycle that best fits your needs. Ensure the size and design of the bike fits comfortably. If you can, try sitting on as many different bikes as you can until you find one that feels right. You should be able to easily reach and use all the controls. Can you get on and off easily? Pick a bike that you can sit on comfortably. It is harder to stay focused on the road and scan effectively for hazards if you are uncomfortable.

Be aware that your motorcycle must have the following equipment installed in order to be legally operated on public roadways in Washington State: mirrors, muffler, horn, license plate, headlight, taillight, and turn signals.

Differences between Two- and Three-Wheeled Motorcycles

There are very different handling capabilities between two- and three-wheeled motorcycles, which is why Washington State requires separate endorsements for both. Make sure that you have the proper endorsement for the type of motorcycle you plan on riding.

When you have finally purchased the motorcycle best suited to your skill level and riding needs, and you have your permit or endorsement, it will be time to practice your skills. Let's have a look at some of the things you should be practicing.

Riding Posture

For balance, control, and safety while riding, practice the following riding posture:

- **Head and Eyes** – keep your head and eyes up, scanning well ahead for hazards. This posture also helps with balance and control.

- **Body** – position yourself comfortably so you are able to operate all of the controls. You should be able to use your arms to steer the motorcycle, rather than hold yourself up.
- **Seat** – sit forward far enough so that your arms are slightly bent when holding the handgrips. Bending your arms permits you to press on the handlebars without having to stretch. Relaxed posture helps you control your motorcycle in a way that allows you to react quickly when responding to hazards.
- **Hands** – hold the handgrips firmly when riding over rough surfaces. Start with a flat wrist position for your right hand, which will help to keep you from unintentionally using too much throttle.

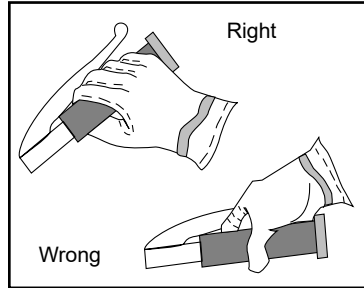

Figure 3-1
Hand positioning

Adjusting the handlebars so your hands are even with, or below your elbows may help you use the proper muscles for steering.

- **Knees** – keep your knees against the gas tank to help you maintain balance and control as you turn, accelerate, or stop.
- **Feet** – plant your feet firmly on the footrests to maintain balance and control, but also position them to easily reach the pedals. Always keep your feet on the foot pegs, since serious injury can occur if you drag your feet while riding.

Basic Controls and Operation

Although most motorcycles have controls in similar locations to each other, please consult the motorcycle's owner's manual to verify control locations and operation specific to your bike.

Practice in a safe and controlled environment until you become comfortable operating each control. Remember to keep your head and eyes up so you can see farther down the road in anticipation of hazards.

Clutch Control and Shifting Gears

Most motorcycles are shifted manually. Practice shifting gears both up and down to develop smooth control. Get used to shifting without looking down at the controls, so that you can keep your eyes up and focused on the road ahead.

Motorcycles typically have a wet clutch, meaning that there is a cooling fluid surrounding the clutch, which reduces the wear and damage to components. This type of clutch also helps to control the amount of power given to the rear wheel, which will aid you in starting out smoothly, as well as maneuvering at low speeds.

Downshifting smoothly to apply engine braking can be a very useful technique on motorcycles--the downside of this technique is that your brake light does not engage to let drivers behind you know you are slowing. If engine braking, flash your brake light a few times to help other road users see you are slowing down.

Two-Wheel Steering

One thing all two-wheeled motorcycles have in common is how they are maneuvered: at approximately 12-15 mph, they steer through a technique known as countersteering. A motorcycle needs to lean in order to turn when traveling faster than a walking pace, and countersteering initiates this lean. To use this technique, press on the grip in the direction that you want to turn.

Countersteering allows the rider to smoothly and effectively initiate motorcycle lean and turn in the direction they want to go. To countersteer, press on the grip in the direction you want to turn. Pressing on the left hand grip causes the bike to lean left and turn left. Pressing on the right handgrip causes the bike to lean right and turn right. Taking a novice motorcycle training course will teach you the basics of countersteering.

Note: Three-wheeled motorcycles (trikes, sidecars, reverse-trikes, etc.) steer via direct steering. This technique is simply turning the handlebars in the direction the rider wants to go.

Cornering

Some of the most fun to be had on a motorcycle is riding Washington's curvy and twisting roads. A large percentage of Washington's motorcycle fatalities are single-vehicle crashes in

corners due to errors in rider judgement: the two leading causes are excessive speed and improper technique. Very often riders take corners too fast and are unable to stay in their lane; they frequently end up crossing into another lane of traffic, or simply going off the road. Sometimes riders overreact and brake too hard, causing a skid and loss of control. One of the most effective ways to reduce your risk in corners is to take training. All two-wheel motorcycle endorsement training in Washington includes an emphasis on cornering strategies and techniques.

Cornering Steps

In order to corner safely, you must approach all turns and curves with caution. Utilize these four steps as a strategy for better control:

- **Reduce speed** before the corner by rolling off the throttle and, if necessary, carefully applying both brakes.
- **Look** as far through the turn as possible by pointing your head and eyes in the direction you want to go (toward the end or exit of the corner). Do this throughout the entire corner. Keep your eyes level with the horizon. If you feel yourself going wide, focus intently on where you want to go.

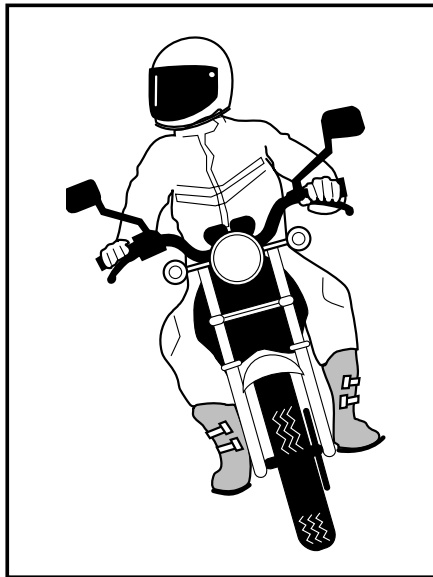

Figure 3-2
Lean with motorcycle

- **Countersteer.** Remember that to turn, the motorcycle must lean. To initiate your lean, lightly press on the handgrip in the direction you want to go. Press left— lean left — go left. Press right— lean right — go right. If you feel yourself going wide, press harder and lean more.
- After you enter the corner, gently and smoothly roll on the throttle to maintain or slightly increase speed, which will help stabilize the motorcycle.

Cornering Lines

Every lane has three positions within which you can ride: outside, middle, and inside, which is also true throughout every corner. Corners have an entry point, a mid-point (or apex), and an exit point. By choosing different lane positions at each of the three points, you can alter your line of travel to suit each corner and increase your level of safety.

Here are three examples of the way you can use lane positioning while cornering:

1. By riding a middle/middle/middle path (Figure 3-3), you typically avoid both oncoming traffic and debris such as gravel. Keep

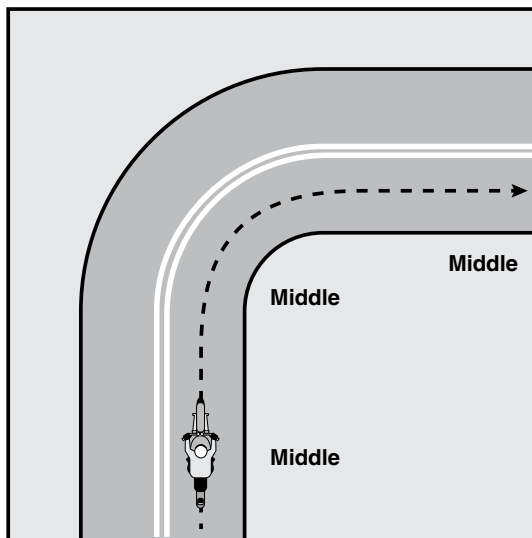

Figure 3-3
Middle/middle/middle cornering line

in mind that sometimes slippery surfaces such as oil drips or leaves can accumulate near the center of the lane. The middle path is generally the safest for less experienced riders.

2. By riding in the outside position at the entry (Figure 3-4), the inside position at the midpoint, and the outside again at the exit, (outside/inside/outside) you can “straighten out” the corner. The straighter the corner, the less lean you need, and thus the more traction you have, which is helpful in case of an emergency

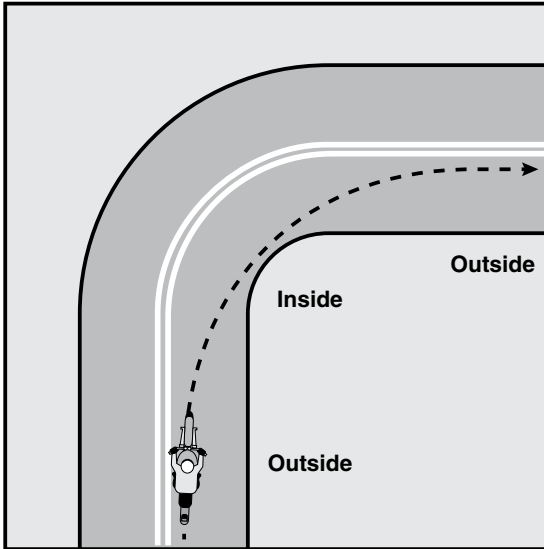

Figure 3-4
Outside/inside/outside cornering line

stop. Starting from the outside lane position also gives you a good view through the corner. Be aware that this line may put you closer to oncoming traffic, or possible debris near the road edge.

3. Riding a “delayed apex” is an advanced cornering technique which involves delayed entry into the apex of the corner. This technique requires you to lean more, but for a less amount of time; it can also help you see farther for a longer period of time, which in turn can set you up favorably for the next corner. Always keep in mind that the longer you remain in the outside position of a right corner, the closer you come to oncoming traffic.

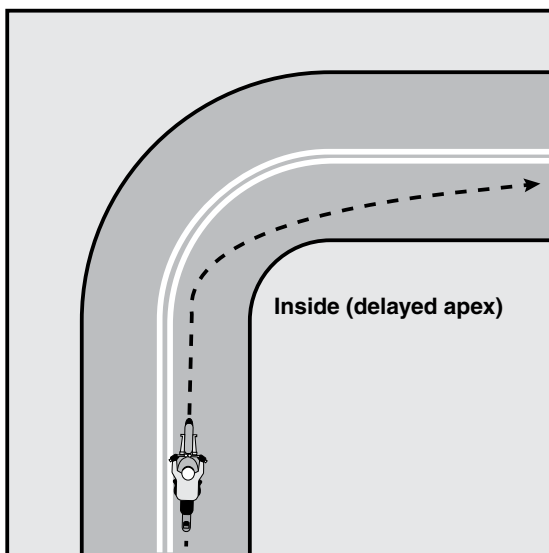

Figure 3-5
Delayed apex cornering line

The most important thing to know about cornering is that every corner you encounter will be different. Approach every corner with caution, even if you have ridden it before. You never know whether surface conditions have changed, if there is a hazard in the road, or if traffic patterns have shifted.

Look, Anticipate, Choose

Look as far ahead in a corner as possible, and gather as much information as you can about:

- Your line of sight—how far can you see through the corner?
- How tight the corner's radius is
- The surface condition of the path you are choosing
- The slope of the corner, which affects your lean angle as well as your speed

Anticipate potential hazards such as cars crossing the center line, wildlife in the road, ice, or gravel on the pavement, and adjust your speed and lane position accordingly.

Choose lane positions throughout the corner to maximize traction and the ability to see and be seen. No matter which path you choose, be sure to keep your head and chin pointed toward the corner exit, and focus on where you want to go.

Braking

Braking in a Straight Line

Improper braking technique is often a common factor in motorcycle crashes. Most often, a rider panics and either under- or over-applies the brakes. If you don't brake hard enough, you may not be able to stop in time before a hazard. If you brake too hard, you may lose traction on one or both wheels and crash.

There is more braking power in the front brake than the back brake because weight transfers forward when slowing or stopping. However, the shortest and safest stops are obtained by using both front and rear brakes in a smooth and progressive manner, without skidding either tire. Practice applying your front brake smoothly, without "grabbing" it to avoid being thrown over the front of your motorcycle.

When you have come to a stop, remain in 1st gear and check your mirrors, in case it is necessary to avoid a rear-end collision.

Practice braking in a safe and controlled environment until you become comfortable stopping safely in the quickest time possible.

Braking in a Corner

When a two-wheeled motorcycle is leaned over in a turn, the amount of traction available for braking is significantly reduced. The greater the lean angle, the less traction available and the greater the possibility of the tires losing traction when brakes are applied.

To stop as quickly and safely as possible in a curve, try to reduce your lean angle, then brake. As you reduce lean angle and straighten, you may ride outside of your lane, so be sure that road and traffic conditions allow this to happen safely.

If road and traffic conditions do not allow you to safely straighten and then brake, smoothly apply the brakes as you gradually straighten your bike. As you straighten, (less lean angle) apply more and more brake pressure. Remember to not apply as much

braking force as you would if the motorcycle were straight up, and to always square your handlebars before you come to a complete stop for stability and control.

The key to avoid braking in a corner is to slow, and then set your entry speed before the corner. Choose your entry speed based on the information you gather about the corner's radius, surface condition, and line of sight. Remember the cornering technique of SLOW, LOOK, PRESS, and ROLL.

Evasive Maneuvers

There are generally two types of evasive maneuvers for when you encounter a hazard on your motorcycle:

- Change speed (speed up, slow down, or stop) or
- Change position (swerve or turn).

Quick Stops

To avoid a hazard such as a turning vehicle, pedestrian, animal, or other object in the roadway, you may need to stop your motorcycle in the quickest and safest way possible. To do so, apply both brakes fully without locking either wheel:

- Smoothly squeeze the front brake firmly and progressively. Squeeze with more force as your front suspension loads. Do not grab the front brake lever. Do not use abrupt pressure on either brake.
- As weight transfers forward to the front during braking, less traction is available to the rear. When using the rear brake, apply light pressure at first, and progressively release pressure off of the rear brake to prevent rear wheel skid.
- Keep your knees against the tank and your eyes up. Look well ahead, which will help you stop the motorcycle in a straight line.

Note: Practice using both brakes even for normal stops to develop the skill and habit of using both brakes. This will develop your muscle memory to help you brake effectively in an emergency.

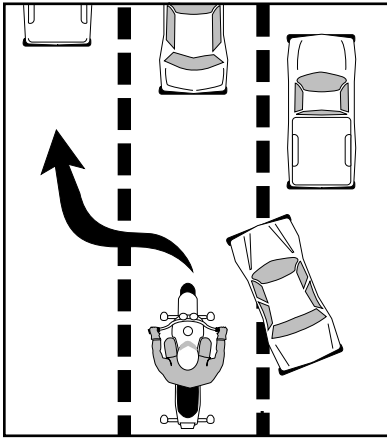

Figure 3-6
Swerve, then brake

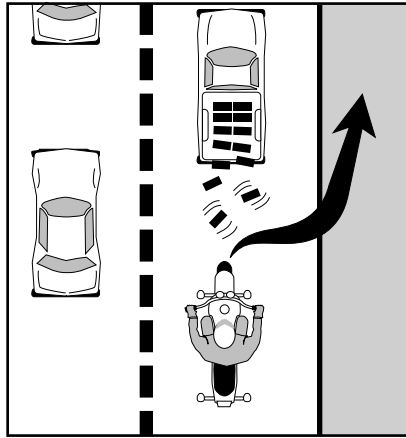

Figure 3-7
Brake, then swerve

Swerves

It is not always safe to execute a quick stop if there is limited space, or if the vehicles behind you are unable to stop. Two-wheeled motorcycles are very maneuverable, so you may be able to avoid a hazard by swerving around it. (Figures 3-6 and 3-7)

A swerve is one countersteer followed by a second: one to quickly maneuver around the hazard, and another to return to your original path. To allow your bike to change direction as rapidly as possible, look in the direction you want to go and keep your body upright and centered, so your bike can move independently beneath you. Swerving is a quick maneuver that requires a lot of traction. In order to preserve traction control, never swerve and brake at the same time. Swerve and then brake, or brake and then swerve.

Swerving can be utilized as a life-saving skill; practice it often in a safe location at varying speeds.

Carrying Passengers and Cargo

Be aware that your motorcycle will handle differently with the additional weight of a passenger and/or cargo. It may take longer to accelerate, and also longer to stop. Your bike may be harder to hold steady and upright at stops, and may behave differently in corners and slow speed maneuvers.

Carrying a passenger is the rider's responsibility; make sure that you are experienced and comfortable enough operating the motorcycle before you take on passengers or cargo.

Any passenger carried on a two- or three-wheeled motorcycle in Washington State must be at least five years old. Passengers must have a passenger seat, footboards or pegs, and are required to wear a DOT-compliant helmet.

A passenger should always mount after you, and dismount before you to help keep your bike stabilized. Adjust your mirrors after passengers are seated and instruct them to keep their feet on the footboards/pegs at all times.

Passengers should lean with you and your bike when cornering and should keep movements to a minimum, especially at low speeds or stops

Make sure cargo is strapped down tightly and centered as low as possible; ensure it does not affect your ability to safely and effectively operate all of the motorcycle's controls.

Your owner's manual will tell you how much weight you can safely carry on your motorcycle, and it may suggest different tire pressures or suspension adjustments for carrying a passenger and/or cargo.

RIDING A THREE-WHEELED MOTORCYCLE

Types of Three-Wheelers: The Right Trike for You

Three-wheeled motorcycles vary widely in type, size, and purpose (Figure 4-1). For example, there are sidecar rigs (A), trikes with one wheel in front and two in back (B), and reverse trikes with two wheels in front and one in back (C). Choose the type of motorcycle that best fits your needs. Ensure that the size and layout of the bike fits you comfortably, and allows for optimal operation of the controls.

Differences between Two- and Three-Wheeled Motorcycles

Three-wheeled motorcycles have significantly different handling characteristics than two-wheeled motorcycles. Washington requires a separate three-wheel endorsement due to the handling differences between two- and three-wheelers. Even an experienced two-wheel rider will find that a three-wheeled motorcycle steers, corners, stops, and balances differently.

Take a three-wheel training course to learn and practice the techniques needed to ride your three-wheeler safely and skillfully.

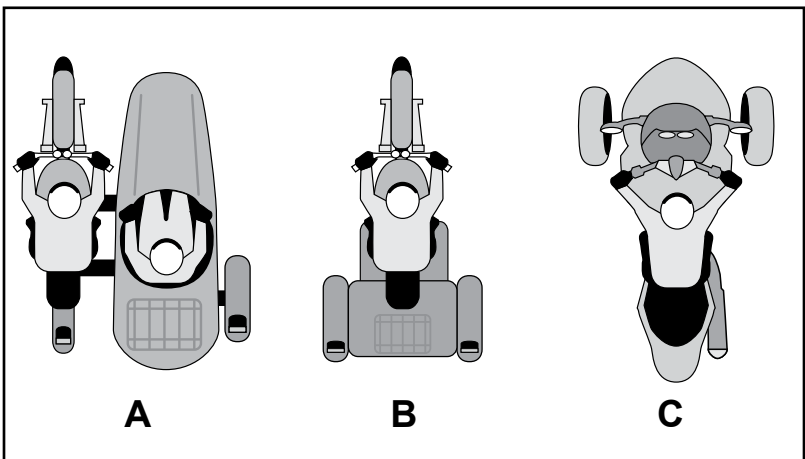

Figure 4-1
Types of three-wheeled motorcycles

Advantages

Three-wheeled motorcycles, often called rigs, have some advantages over their two-wheeled counterparts:

- They are typically more stable than a two-wheeler
- They do not require you to hold them upright at a stop
- They can slide sideways while braking without falling down
- Three-wheelers tend to be larger, which makes them more visible
- They can carry passengers and cargo easier than two-wheelers due to their size.

Disadvantages

Three-wheeled rigs have disadvantages due to:

- Their larger size, which makes them more visible, but means less maneuverability and more weight which in turn can affect acceleration negatively.
- More weight, which can also make some three-wheelers (especially motorcycles equipped with sidecars) take longer to stop.
- Higher fuel consumption due to more weight, as well as more engine and tire wear. Make sure to complete pre-ride inspections for your three-wheeler before every ride.

Riding Posture

For better control, perform the following:

Posture/Seat — position yourself comfortably so you are able to operate all of the controls, which will allow you to use your arms to steer the rig rather than to hold yourself upright. Sit far enough forward so that your arms are slightly bent when you hold the handgrips; this allows you to maneuver the rig more effectively. Utilizing correct posture will allow you to more quickly respond to hazards.

Hands — hold the handgrips firmly, but not tightly to keep your grip when riding over rough surfaces. Hold your right wrist flat when you can for both better control of the throttle, and to keep you from accelerating unintentionally. Adjust handlebars so your hands are

even with, or below your elbows. A relaxed position will be more comfortable, but also allows for improved handling of your rig.

Feet — serious injuries may occur, and control of your rig can become difficult if your feet are placed on the ground during operation. Rest your feet firmly on the footrests near the controls to keep away from any moving parts.

Body Position — you must shift your body position while cornering on your three-wheeler. Lean and/or shift your body weight in the direction you intend to turn to avoid raising the inside wheel; this is especially important with sidecar rigs during right turns to avoid a rollover crash.

Basic Controls and Operation

Most three-wheelers have controls in similar locations to each other. Please consult the owner's manual to verify control locations and operation specific to your rig.

Practice in a safe and controlled environment until you become comfortable operating each control without looking down. The best way to become familiar with your trike is to take a training class.

Clutch Control and Shifting Gears

Always consult your owner's manual to verify the type of transmission your rig is equipped with, and its operation. Some three-wheelers shift manually, and some shift either partially or fully automatic. Practice shifting both up and down to develop smooth control.

Most fully-manual rigs have a wet clutch that allows you to slip the clutch, which helps control the amount of power given to the rear wheel(s).

Slipping the clutch is a fundamental skill to learn and practice, since it aids your control of the rig when you are maneuvering at slow speeds.

Utilizing engine braking power by downshifting is a useful technique with a disadvantage: your brake light does not engage to let drivers behind you know that you are slowing.

When engine braking, flash your brake light a few times to help other road users see that you are slowing down.

Unique Handling Characteristics

Three-Wheel Steering

Under normal conditions, three-wheelers use direct steering, which is simply turning the handlebars in the direction the rider wants the vehicle to go.

Tip-Over Lines

Tip-over lines are inherent in the design of all three-wheeled motorcycles (Figures 4-2, 4-3, 4-4). A line drawn between any two wheels on your rig represents a tip-over line, and each tip-over line is like a hinge point. When enough weight is placed outside a tip-over line, or when cornering forces shift the center of gravity outside a tip-over line, it is possible for a three-wheeled motorcycle to lift a wheel off of the ground. Tipping occurs most frequently during tight maneuvers or when turning at higher speeds; in extreme cases the rig can actually roll.

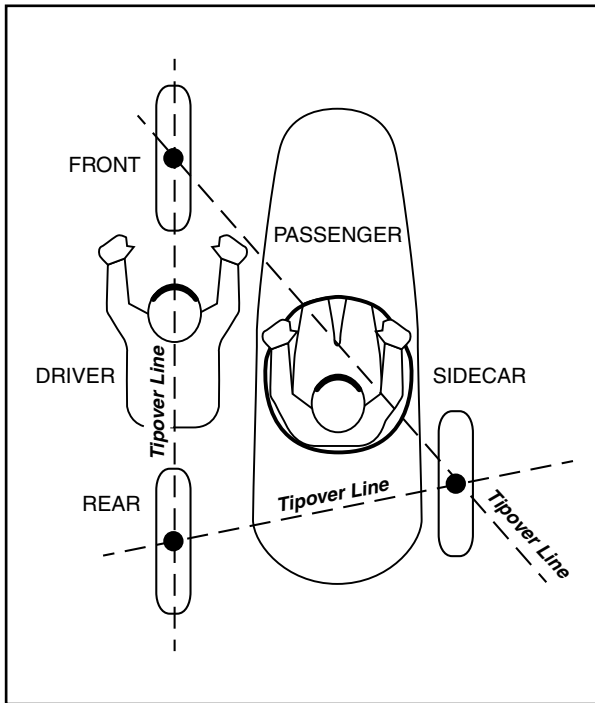

Figure 4-2
Tip-over lines: Sidecar rig

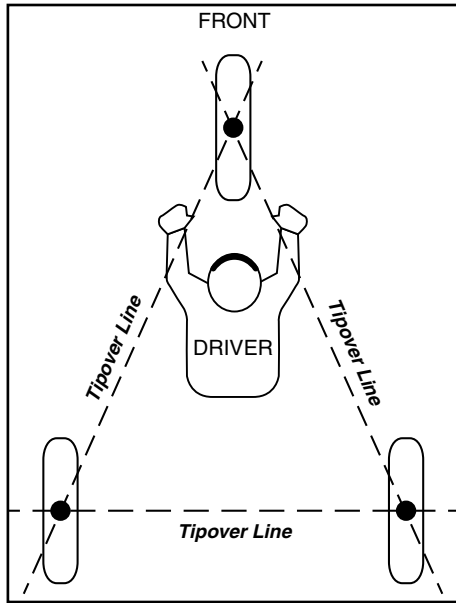

Figure 4-3
Tip-over lines: Trike

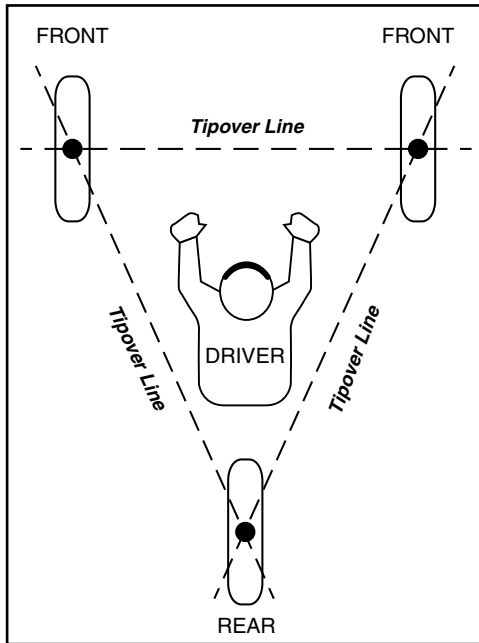

Figure 4-4
Tip-over lines: Inverted trike

Tip-over lines are most noticeable when operating sidecar rigs. A shift of weight or centrifugal force can easily lift the sidecar wheel. With practice and experience, a sidecar-equipped motorcycle can be operated while riding upon only two wheels of the motorcycle, which is called “flying” the sidecar, something not recommended on public roadways.

To maintain stability, careful positioning of loads and passengers within the tip-over lines is required in order to reduce the possibility of lifting a wheel, or rolling the rig. The lower and more centered cargo or passengers are, the more stable your three-wheeled motorcycle will be.

“Flying” and Steering Reversion

Only two of three wheels are in contact with the ground when flying a rig. A balance point can be reached at a certain speed, and that is when steering reversion takes place. Steering reversion is when a three-wheeler (typically a sidecar rig), that is normally controlled by direct steering, temporarily balances and operates on only the two wheels of the motorcycle; when this happens, steering reverts to countersteering.

To bring a flying wheel to the ground, you can do one or more of the following: (a) lean into the lift, (b) lightly apply the front brake, or (c) roll off the throttle slightly. The best way to understand and control flying a wheel is to practice in a safe and controlled location, and by taking training.

Yaw

When starting out from a stop on a sidecar rig, you may feel the weight of the sidecar pulling the vehicle slightly to the right. This pull is called “yaw” (Figures 4-5, 4-6). You can counteract yaw by steering slightly to the left when starting out, which will help you stay in your lane.

You also feel yaw when you are braking on a side car rig. When braking on a motorcycle with a sidecar, especially one that doesn’t have a brake on the sidecar wheel, you may feel some thrust to the left. Compensate for yaw by steering slightly to the right in order to maintain your path of travel and stay within your lane.

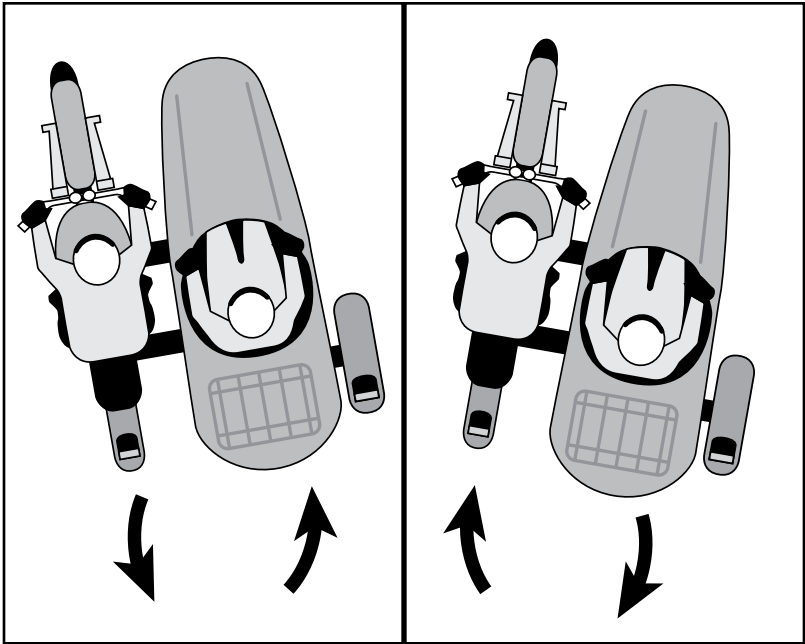

Figure 4-5
Yaw under deceleration

Figure 4-6
Yaw under acceleration

Cornering

Some of the most fun on a motorcycle is riding Washington's curvy and twisting roads. A large percentage of Washington's motorcycle fatalities are single-vehicle crashes in corners due to errors in rider judgement: the two leading causes are excessive speed and improper technique.

Often riders take corners too fast and are unable to stay in their lane; they frequently end up crossing into another lane of traffic, or simply going off the road. Sometimes riders overreact and brake too hard, causing a skid and loss of control.

One of the most effective ways to reduce your risk in corners is to take training. All three-wheel motorcycle endorsement training in Washington includes an emphasis on cornering strategies and techniques.

Keep in mind that with increased speeds and tighter curves, there is a potential for the inside wheel of your three-wheeler to lift. Tipping occurs when weight and/or the center of gravity is transferred outside a tip-over line.

Cornering Steps

In order to corner safely, approach all turns and curves with caution. Perform these five steps for better control (Figure 4-8):

1. **REDUCE** speed before the corner by rolling off the throttle and, if necessary, applying all brakes.
2. **LOOK** through the turn by pointing your head and eyes in the direction you want to go (toward the end or exit of the corner). Do this throughout the corner. Keep your eyes level with the horizon. If you feel yourself going wide, focus more intently on where you want to go.
3. **LEAN** your upper body in the direction you intend to turn to help maintain stability.
4. **POINT** the front wheel/wheels toward the turn.
5. After you enter the corner, smoothly **ROLL** on the throttle to maintain or slightly increase speed; this helps pull your three-wheeler through the turn.

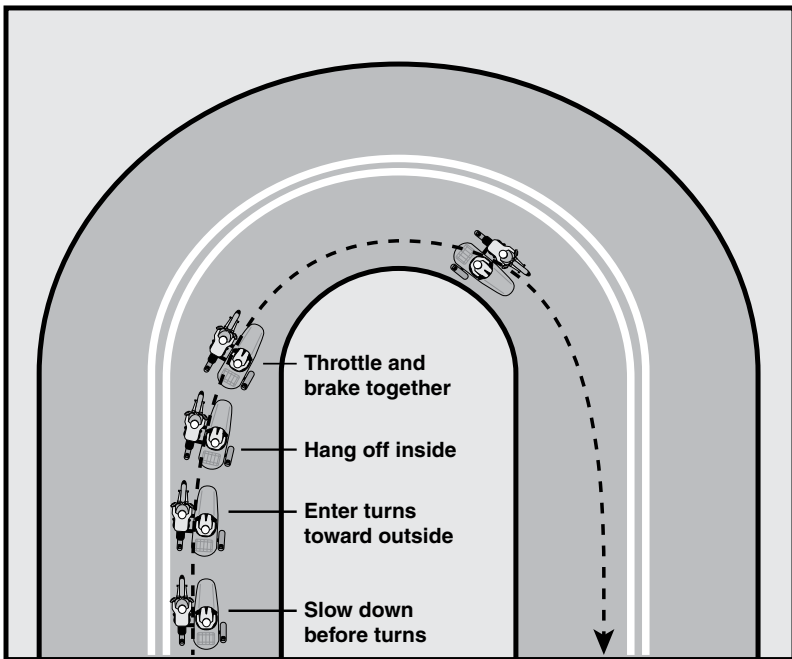

Figure 4-8
Three-wheel cornering technique

When Turning a Trike

The weight of most trikes is distributed almost equally side to side; as a result, these motorcycles handle the same in both left- and right-hand turns.

When Turning a Sidecar Rig

Since the weight of the sidecar rig is not always distributed equally from side to side, the handling characteristics differ from standard trikes. During a right turn, side force pulls the rig toward the outside of the turn and creates a possibility for the sidecar wheel to lift. The sidecar will lift easily in a turn if it is empty or only lightly loaded.

Using the same cornering steps as above while making sure to lean into the right turn will reduce the possibility of your sidecar lifting from the ground.

During a left turn, the side force pushing to the outside of the turn adds weight to the sidecar wheel, helping it stay in contact with the ground. A transfer of weight to the left can cause the suspension to extend, reducing traction available for steering and speed control. In extreme cases it could cause the nose of the sidecar to dig into the pavement, causing the sidecar rig to flip.

Hills

When riding uphill on a three-wheeled motorcycle or sidecar-equipped motorcycle, some weight will shift to the rear, which can cause the front of the motorcycle to become lighter. An uphill shift in weight can reduce the traction on the front tire(s), which may reduce steering ability and tire grip.

When riding downhill, gravity will shift some weight to the front tire(s). A downhill shift in weight can increase the amount of braking force available, but it can increase weight to the point that a tire will slide when braking.

If the front tire starts to slide, steering ability is lost, which is why it is important to begin slowing earlier and smoother when cornering, but also when stopping downhill to maintain traction and steering ability.

When riding a sidecar downhill it is even more important to adjust speed prior to entering a turn, especially in right hand turns. In downhill right-hand turns, both cornering forces and gravity are

pulling the rig toward the outside of the curve, which can cause the sidecar to lift and tip to the left.

*Remember, it is much easier to speed up in a corner than it is to slow down in one, therefore always adjust your speed before entering a corner.

Drifting

As discussed earlier, centrifugal force pulls a three-wheeler toward the outside of corners and may cause an inside wheel to lift. To reduce this side force and help keep all wheels on the ground, you can use a technique called “drifting”. Drifting is a technique that uses steering, braking, and throttle to slightly slide the rear tire(s) toward the outside of the corner. This subtle drift can help disperse side loads and increase stability as you maintain directional control. The best way to learn and practice this important technique is to take a three-wheel training course.

Braking

Braking in a Straight Line

Improper braking technique is often a common factor in many motorcycle crashes. One of the advantages of three-wheeled motorcycles is that you can brake much harder than on a two-wheeler and still maintain traction.

To achieve the shortest and safest stops, apply all brakes on your rig simultaneously (Figure 4-9). Apply brakes in a smooth and progressive manner. As you come to a stop, the weight of your three-wheeler shifts forward, so do not “grab” the brakes in order to avoid skidding. On a sidecar rig or a reverse trike, a forward shift in weight increases the effectiveness of your front brake – making it more powerful than the rear brake(s). Apply all brakes up to, but not beyond, the skid point.

When coming to a stop, remain in first gear (on a manually shifted rig) so that you can take off rapidly if necessary, to avoid a rear-end collision.

Braking in a Corner

To stop as quickly and as safely as possible in a curve, use all of your brakes smoothly and progressively. Traction is reduced

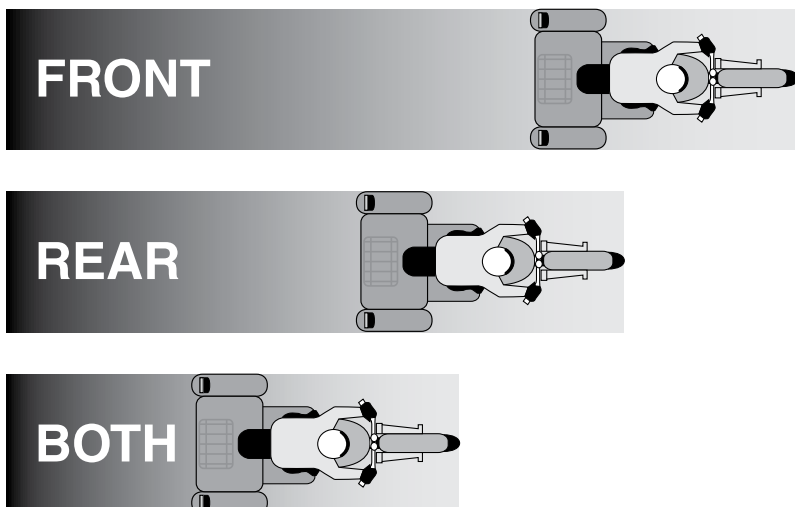

Figure 4-9
Stopping distances

while turning a three-wheeler, which affects how much traction is available for braking. Do not exceed your traction limits, which could cause a skid and the potential to slide out of your lane.

Evasive Maneuvers

There are generally two types of evasive maneuvers you can execute on your three-wheeler:

- Change speed (stop, slow down, or speed up)
- Change position (swerve or turn).

Quick Stops

A quick stop is often the safest evasive maneuver for avoiding collisions or other hazards in traffic on a three-wheeler:

- Fully apply all brakes smoothly and progressively without locking any wheels
- Prepare to account for a sidecar's tendency to yaw left when stopping
- Keep your knees against the tank and keep your eyes up looking well ahead; this will help you stop in a straight line.

Practice using all brakes for non-emergency stops to develop the muscle memory which will help you brake properly in an emergency. The best place to practice your emergency braking skills is in a safe and controlled location.

Swerves

Swerving is an option for avoiding a hazard, but because of the handling characteristics of three-wheelers, the sudden side loads experienced within a swerve can upset the suspension of the rig, causing a tip- or roll over. Tipping or rolling over is more likely when on a sidecar due to the tip over line .

Keep in mind that there is less room to swerve around vehicles or obstacles because of a three-wheeler's size. If you do need to swerve, remember to shift your weight into each directional change to help keep all wheels on the ground. You may just find that executing a quick stop is safer and more effective on a three-wheeler after all.

Practice swerving in a safe location, and at varying speeds. Also practice shifting your weight while you are cornering to build the habit for when you may have to utilize a swerve.

Carrying Passengers and Cargo

Passengers carried by either two- or three-wheelers must be at least five years old. Passengers must have a passenger seat and foot pegs/boards, and they must wear a DOT-compliant helmet.

To account for tip-over lines, a single passenger on a sidecar rig should be positioned in the sidecar and not on the rear seat of the motorcycle. If riding with two passengers, the larger passenger should be in the sidecar to minimize lift when turning.

When securing cargo, account for tip-over lines by centering as much weight as possible within the tip-over lines.

Your owner's manual will tell you how much weight you can safely carry on your trike; it may also suggest different tire pressures or suspension adjustments for carrying a passenger and/ or cargo.

Understand that your rig will handle differently with the additional weight of a passenger and/or cargo: it may take longer to accelerate, longer to stop, and may behave differently in corners.

STRATEGIES FOR THE STREET

Street Strategies

You can develop the physical skills to operate a motorcycle with continued practice and training, but it takes the same effort to develop your mental skills for riding. Awareness, focus, and strategic thinking are the mental skills that may contribute even more to your safety than your physical abilities. You may have excellent swerving skills, but if you recognize a hazard early through strategic thinking skills, you may never need to put your hazard-avoidance skills to the test. Proactive strategy can help you see hazards early, so you can plan to negotiate them safely instead of as an emergency situation.

Seeing and Being Seen

The strategies below are all useful techniques to increase your visibility, as well as your ability to see what is ahead of you.

Lane Choice

One of the ways you can increase your ability to see and be seen is by choosing the best possible lane, and then the position within that lane in which to ride (Figure 5-1).

Appropriate lane choice can help you to see farther down the road and help other road users see you better. Keep in mind that riding between lanes, commonly known as “lane splitting”, and riding on the shoulder is against the law in Washington State.

You should constantly evaluate what the best lane and position is in which to ride. Think about advantages and disadvantages for each lane, and which one serves you best at the time.

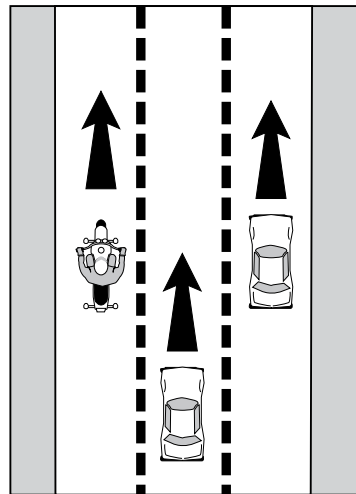

*Figure 5-1
Lane choice: far left lane*

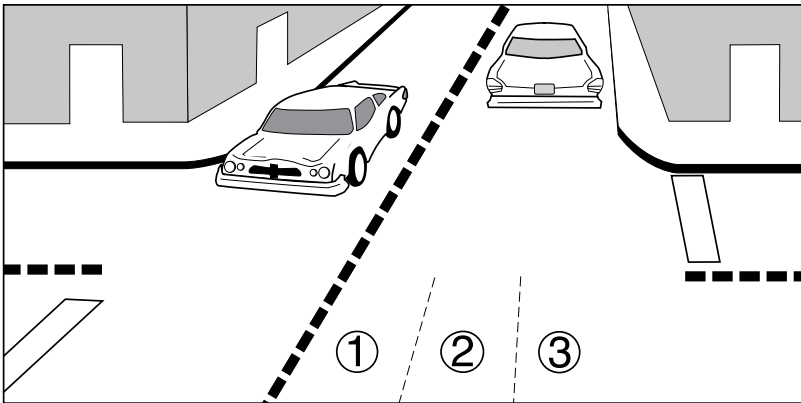

*Figure 5-2
Choose the best lane position*

Consider this example (Figure 5-2):

Some of the advantages of riding in the left lane could be:

- It might be less crowded
- It could be moving faster
- There is a possible escape path to the left
- You typically only have to be concerned about traffic on one side of you.

Some disadvantages of riding in this lane could be:

- It may be moving faster than you want to go.
- If traffic is backed up, vehicles may suddenly switch into your lane in front of you — possibly without looking.
- What if you need to exit, but that exit is accessed only by the far right lane?

Traffic and surface conditions change, therefore riders must always be scanning for hazards. Choose the lane that serves you the best at any given moment. Switch lanes frequently to address ever-changing circumstances, and to give yourself an adequate safety margin of time and space.

Note: In Washington State, motorcycles are allowed to use the HOV (diamond) lanes at any time.

Lane Position

Have you ever moved over a bit within your lane to try and see around the vehicle ahead of you, or shifted to avoid a hazard while driving your car? Riding a motorcycle gives you even more room within your lane to change positions.

There are three positions in each lane that motorcycle riders can use: the outside, the middle and the inside portion of the lane.

Most three-wheeled motorcycles are more limited than two-wheelers in their choice of lane position because of their size — but even small adjustments can help you negotiate hazards, see around the vehicle ahead of you, or make yourself more visible to other road users.

You can choose which position is best within your lane; each has advantages and disadvantages.

For example, some of the advantages of riding in the left position of a lane are:

- You may be able to see around the vehicle in front of you
- Other road users may be able to see you better
- The driver in front of you may see you better in their side mirror

Some of the disadvantages of riding in this position could be:

- You are closer to oncoming traffic
- You may be more affected by wind blasts from oncoming vehicles and semi-trucks

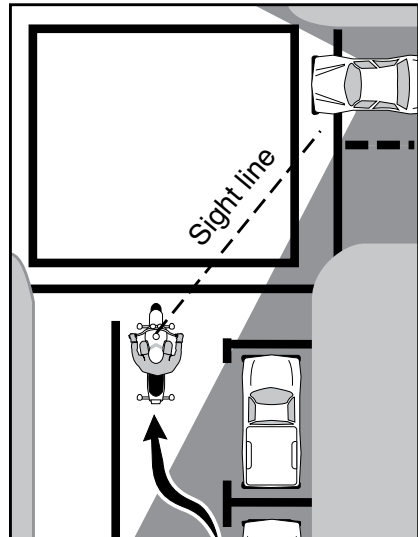
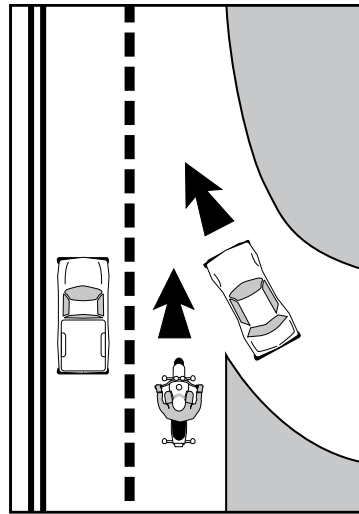

*Figure 5-3
Improving your line of sight
by using the left lane position*

What is the best lane position in which to ride? It is the one that allows you the best chance to see, be seen, and to quickly avoid hazards. Lane positioning is dynamic, which means that lane position changes constantly with every new hazard or change in traffic (Figure 5-4).

Being Visible

The most common comment from drivers after colliding with a motorcyclist is, "I didn't see you." Make yourself visible!



*Figure 5-4
Merging traffic*

Choose the lane and position that increases your ability to see and be seen. Recognize and move out of other vehicles' blind spots. (Figure 5-5).

- You can increase your visibility by:
 - Wearing brightly or lightly-colored gear
 - Wearing gear with retro-reflective strips or panels
 - Adding auxiliary lights to your motorcycle
 - Ensuring you use your turn signals
 - Flashing your brake light when slowing through the use of engine braking.

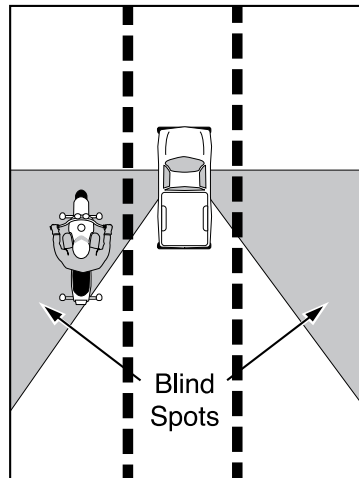

*Figure 5-5
Avoid blind spots*

What helps you notice motorcyclists when you are on the road? Your answer to this question can help further develop your strategy to be more visible.

Creating Time and Space

Your street strategy of seeing and being seen will be even more effective if you create time and space around you. Time allows you to see a hazard and plan a response. Space gives you the time and room to execute your plan. The earlier you identify potential hazards by looking farther ahead, the more time and space you have to respond.

You should constantly evaluate current road and traffic conditions: choose your lane and position accordingly and ask yourself, “What if...?” Take personal responsibility for creating time and space around you. You must continuously evaluate road and traffic conditions, adjust your speed, and change lane positions to create the time and space you need to be safe.

ALWAYS evaluate an escape path as part of your time and space choice.

Total Stopping Distance

It takes more time and space to stop your motorcycle than a four-wheeled vehicle. These are the three factors that make up total stopping distance:

- **Perception** — amount of time it takes you to notice a hazard.
- **Reaction** — amount of time it takes for your brain to send a signal to begin reacting.
- **Execution** — carrying out the appropriate action.

You spot a deer as you are riding at 60 miles per hour (90 feet per second) on a two-lane highway; while carrying out the three factors that make up total stopping distance, you will have travelled an average of about 360 feet.

How can you create the time and space necessary to respond safely and effectively to a hazard? One of the most effective ways is by keeping your eyes up and looking as far down the road as you possibly can.

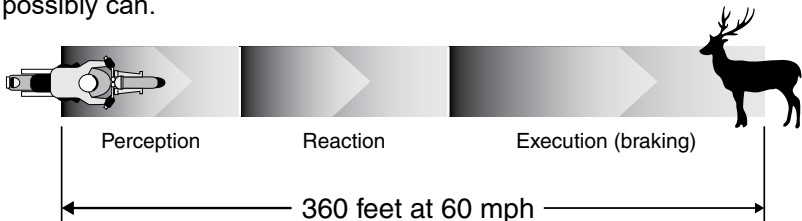

Figure 5-6 Braking distance

Look Farther Down the Road

Imagine someone is going to throw a ball to you. Would you prefer if the person states that they are going to throw the ball, or not? If the person tells you that they are planning on throwing the ball, you can prepare for it to come your way. The more time you have to prepare for the object to come your way, the better you can perceive, react, and execute your plan; it is the same when riding your motorcycle.

Do not override your sight distance by riding faster than you can respond to hazards. Whether on two or three wheels, strive to see at least 12 seconds down the road ahead of you. Where on the road will you be in 12 seconds? What are the potential hazards? Is there a vehicle with its brake lights on? Is there a construction zone? Is there a deer by the side of the road? What about other traffic? Ask yourself, "In which lane should I be? Which position should I choose within my lane? How do I prepare for what is ahead?"

Constantly scan the road to evaluate your risk and identify all potential hazards. Create time and space for yourself by managing your distances all around you, and by looking as far down the road as possible.

Following Distance

Always keep an appropriate following distance to reduce the risk of rear ending a vehicle in front of you.

As the rider, you must create more space and time by managing the distance at which you follow the vehicle ahead of you.

A minimum following distance of three seconds is recommended for both two- and three-wheeled motorcycles. Remember that three seconds is the absolute minimum, meant for ideal conditions. You should adjust your following distances to account for things like weather, fatigue, poor surface conditions, and traffic.

Being Followed

Whether stopped or moving, check your mirrors often so you can be aware of what is going on behind you. Remember, potential hazards can occur from all directions.

If you are being followed too closely, which is often called "tailgating," try to resist the temptation to speed up. Speeding up

in this situation typically encourages the driver behind you to speed up as well, essentially “trapping” you between two vehicles--the resulting time and space cushion created can quickly turn hazardous.

If you are being followed too closely, gradually slow down to create more space between you and the vehicles in front of you. Extra space will offer you more time to react to any possible hazards, sudden moves, or stops by the vehicle ahead of you. By slowing down you have created an escape path in the form of time and space, and reduced your risk of a crash.

Proactive Strategy

What can you do to reduce your risk while riding your two- or three-wheeled motorcycle on the street? Develop both your physical and mental skills through awareness, training, and constant practice. Proactively create time and space for yourself by:

- Being aware, and actively making choices that help you see and be seen
- Continually scanning as far ahead as possible
- Choosing the best lane and lane position for your current situation
- Managing the distance between you, other road users, and hazards.

Roadway Management Skills

During each day you spend on the road, you will encounter many different roadway features, surface conditions, and traffic situations.

Intersections

The majority of motorcycle vs. vehicle collisions occur at intersections. The most common type of this collision is when a car turns left across the path of the motorcycle (Figure 5-7).

Intersections are often busy and crowded with a variety of road configurations, traffic lights, signs, and other obstacles. In addition, intersections often have features that create blind spots, making it more difficult for a rider to see and be seen. Choose a speed and lane position that maximizes your ability to see and be seen, and that accounts for surface and traffic conditions.

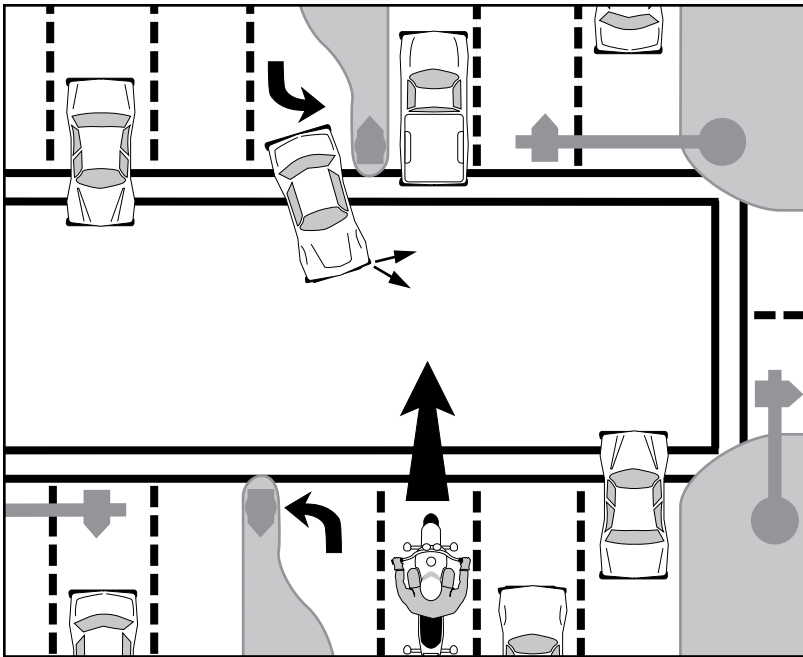

*Figure 5-7
Watch for turning cars*

Riders should always:

- Look for escape routes in case of an emergency
- Look for roadway hazards and monitor traffic conditions
- Remain in first gear at intersections, and check mirrors often to help avoid rear-end collisions
- Make sure that other road users have stopped prior to proceeding through intersections.

When you notice a car waiting at a green light, you should predict that they are waiting to turn and react accordingly. Make sure the right-of-way is clear and safe before proceeding. “Cover” your controls (getting ready to operate the clutch, brakes, etc.) so you can use them quickly if necessary.

Surface Hazards

Slippery surfaces, like painted lines or arrows on the roadway, leaves, oil spots, steel construction plates, drainage grates,

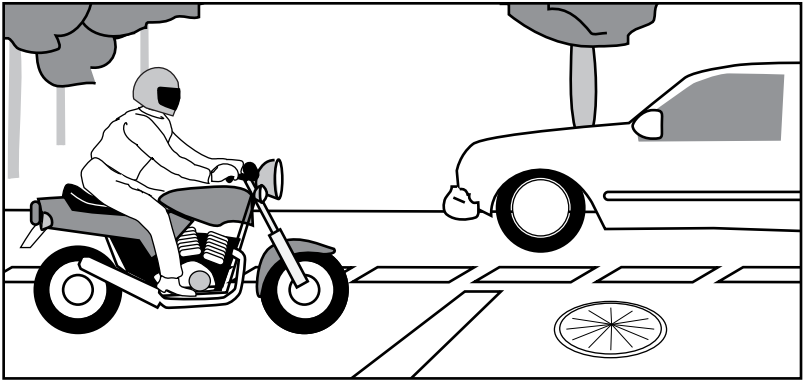

Figure 5-8 Surface hazards

manhole covers, and gravel can all pose hazards, especially to two-wheelers.

To help spot such hazards, look ahead for any changes in color or texture on the road surface. Different road surfaces will affect a motorcycle by changing traction and tire grip. Keep in mind that after the first rainfall of the season, roads may be even more oily and slippery (Figure 5-8).

To help maintain the maximum amount of traction while travelling over a slippery surface, minimize any speed and directional changes. If you need to adjust speed or position, do it before you come to the slippery surface. Handle your controls gently when traveling over anything assumed slippery.

You go where you look, so keep your eyes up the road instead of fixed on the slippery surface or hazard.

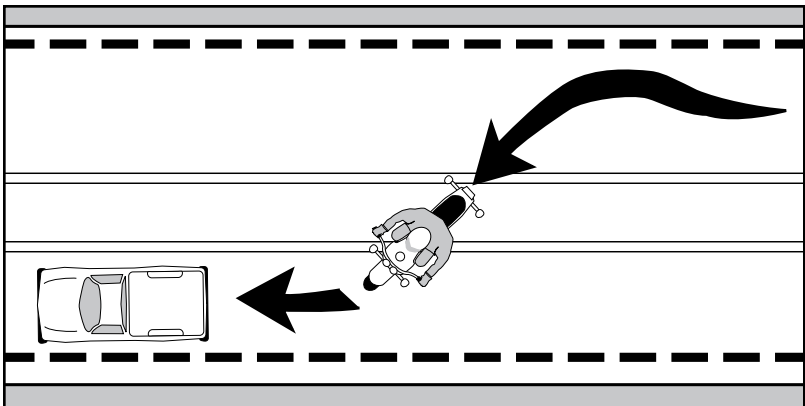

Figure 5-9 Crossing parallel railroad tracks

Crossing an Obstacle

There are times when you may need to cross over an obstacle. Obstacles may include railroad tracks, speed bumps, or debris on the road surface.

Approach any obstacle at as close to a 90-degree angle as possible (Figure 5-9). Keep your head and eyes up, looking as far ahead as possible.

Do not fixate on an object by looking down at it. If possible, try to raise yourself off of the seat a bit to let your legs act as shock absorbers. By raising yourself off the seat, you put more weight on the foot rests, which lowers your center of gravity; this can help maintain stability, especially for two-wheeled motorcycles.

Just before your front tire crosses the object, add a bit of throttle. Then as your front tire passes over the obstacle, roll off the throttle. This technique can help lighten your front end suspension and aid the front tire(s) in moving across the object.

Changing Lanes

When you change lanes, check over your shoulder to make sure there are no vehicles in your blind spot. Your motorcycle will tend to go where you look, so make sure that you maintain a straight path while you are doing this. Use your turn signals to communicate your intention before changing lanes (Figure 5-10), and remember to cancel them when you have completed your maneuver.

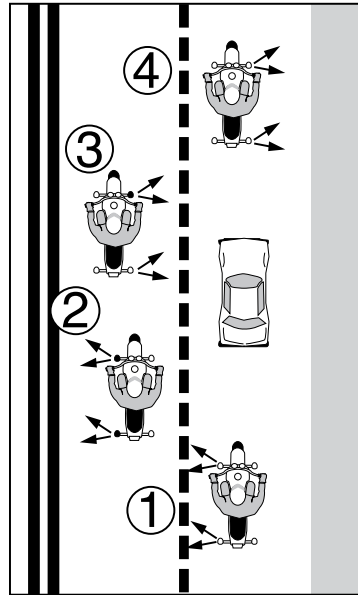

Figure 5-10
Changing lanes

Passing

The risk associated with passing generally comes from failure to check your mirrors and blind spots. The most effective way to pass another vehicle is:

- Plan your move
- Move to the left side of your lane to increase your line of sight
- Before passing another vehicle, make sure that the vehicle is not about to turn
- Make sure that you are in a passing zone
- Signal, then check your blind spot
- When you are certain it is safe, change lanes
- Cancel your signal after completing the maneuver

Note: Although it may be legal to pass in an area, be aware of driveways, and cars that may pull out in front of you.

Riding at Night

Motorcycle headlights are generally smaller, and not as powerful as those in cars; this makes seeing and being seen harder for you while riding at night. You may consider altering your route to one that is wider, straighter, better lit, and with less hazard potential.

To help compensate for the increased risk of riding at night:

1. **Reduce Your Speed** — ride even slower than you would during the day, particularly on roads you don't know well; this will increase your chances of avoiding a hazard. It is harder to see a hazard ahead when riding at night--don't ride so fast that you cannot stop quickly enough when you see a hazard in your headlight. If you can't see well, slow down.
2. **Increase Distance** — distances and hazards are harder to judge at night than during the day. Your eyes rely upon the contrast of shadow and light to determine how far away an object is, and how fast it may be coming. Contrasts are distorted and shadows are less defined at night. To be safe, increase your following distance accordingly.
3. **Use All Light Sources** — sometimes the headlights of a vehicle in front of you can help give you a better view of the road at night; change lane positions to achieve this. Watch for brake lights, since they can be a good indicator of dangers: if you see brake lights ahead of you being activated or bouncing up and down, there may be rough pavement or bumps in the road. Using other cars' lights can be beneficial, but may also

obstruct your view if coming head on. If you cannot see, look to the fog line or white line on the shoulder and use it to guide you down the road.

*Note: Wildlife is more active between dusk and dawn.

Target Fixation

Target fixation is when you stare at an object or area so intently that you end up moving toward it.

When you stare at an object or area while riding, you go where you are focusing, which means that you could potentially run into a hazard in the road instead of avoiding it.

New riders often run the mistake of becoming distracted by details that are unimportant, which can lead to target fixation. Say you are taking a corner and find yourself staring at the guardrail; there is a high probability that you will find yourself drifting toward that area: this is an example of target fixation. Look where you want to go, not at the hazard.

Make sure you are training your vision to look farther ahead through the line of sight, but also choose a lane position that allows you to identify and overcome obstacles in a safe manner. The only way to develop good “motorcycling vision” is to consciously practice until it becomes second nature.

Group Riding

Riding in a group can be fun and rewarding, but it can also be distracting and stressful. Newer riders should wait and gain experience before riding within a group.

Before any group ride, reflect on the following:

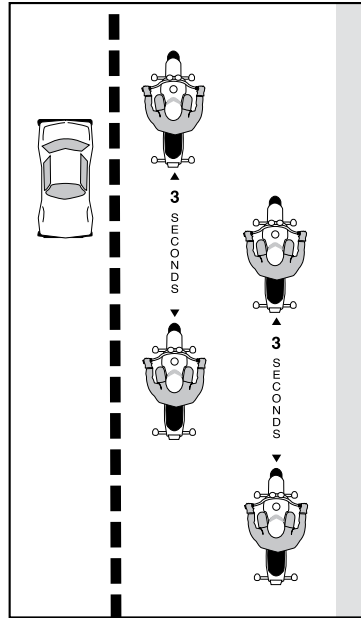

Figure 5-11
Staggered formation

Give Each Other Space

In Washington it is legal for two motorcycles to ride side-by-side within the same lane. However, if you choose to ride side-by-side, be cautious-- there is no place to go if you have to maneuver to avoid a car or hazard in the roadway. Riding side-by-side severely impacts your time and space cushion. Choose to ride safe, choose to ride with space!

Staggered Formation

Riding side-by-side severely limits your ability to respond to hazards. Most groups of two-wheel riders choose to ride in a staggered formation, which is typically the best way to keep the group close while maintaining an adequate space cushion between riders.

In curves, areas of limited visibility, or areas where more time and space is likely needed, bikes should move to a single-file formation. Single file allows each rider to use appropriate cornering techniques by utilizing any or all lane positions. Single file formation during right-hand cornering also prevents riders who would be on the outside in a staggered formation from having to crowd the centerline close to oncoming traffic. In any position, remember to ensure you have a minimum three-second following distance behind the rider in front of you.

Ride Your Own Ride

Remember that even in a group you are responsible for creating your own safety. If you need to change your position within a formation to avoid a potential hazard, do so. If other group members are riding too fast or exhibiting dangerous behavior, do not compromise your safety trying to keep up or fit in.

IMPAIRMENTS

Types of Impairments

As much as you need to be aware of traffic and potential hazards, you must also be aware of potential distractions and impairments:

- Alcohol, drugs, and even some medications can degrade your riding abilities
- Listening to music or using devices such as cell phones, GPS, and intercoms can affect your focus when riding
- Adjusting electronic controls and features on your bike can be distracting and quickly degrade your ability to scan for hazards and react to them
- Emotional and physical states such as fatigue, anger, illness, stress, and fear can impair your riding skills. You are in fact more likely to miss important cues or hazards while riding impaired or distracted
- Group riding has the potential to impair your use of street strategies, as well as your ability to make safe choices due to peer pressure, increased anxiety, and added distractions.

Prior to leaving on a ride, consider the environment in which you plan to ride. Be aware that you are a part of that environment. Are you tired, emotionally distraught, or distracted? Have you had a drink or two? Have you taken any prescription or over-the-counter medications? Are you on an unfamiliar route and trying to navigate with a GPS unit? Are you ready to ride within a group?

It is easy to become impaired. Impairments can often sneak up on you and reduce your ability to identify hazards and respond safely.

Alcohol and Drugs

Alcohol is one of the most common factors in Washington State's motorcycle crashes and fatalities. Alcohol quickly affects a rider's judgment, vision, attention, and fine-motor skills--this impairment begins at the first drink.

Responsible riders choose to drink or choose to ride. Statistics show that consuming alcohol or drugs while riding is often a deadly choice. Riding under the influence poses risks to you and to other

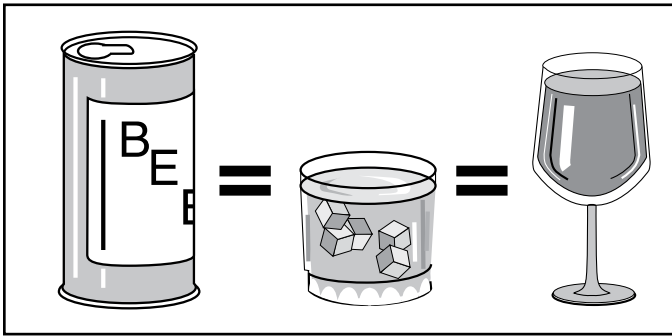

drivers, and it is also illegal to ride under the influence of alcohol or drugs in Washington State.

Would you want your friends or family riding with other drivers who have been drinking? Find alternate forms of transportation for yourself or anyone who may be impaired.

Alcohol takes an average of one hour per drink to leave your system. The more drinks you have within an hour, the longer it takes your body to process.

One drink is considered:

- A 12 oz. beer
- A 5 oz. glass of wine
- 1 ½ oz. of hard alcohol

The only thing that can remove alcohol or its effects from your body is time. Eating, drinking coffee, or taking a cold shower will have no effect on the level of alcohol within your body. As long as alcohol is still within your system, it is impairing your judgment, vision, attention, and motor skills.

Alcohol, legal and illegal drugs, and some medications impair your ability to ride safely. Be aware that when combining any of these, the effects are typically compounded. Just one drink combined with an over-the-counter medication can have a significant impact upon your judgment, vision, attention, and motor skills. Using cold remedies, allergy medicines or any other over-the-counter drugs alone can affect riding ability just as much as alcohol and illegal drugs. Remember, operating a motorcycle requires dividing attention that is challenging even when sober.

Marijuana

Marijuana slows reactions, inhibits concentration, and distorts your perception of time and distance; its effects become most evident when reacting to an unexpected situation. Just as alcohol affects a rider's judgment, vision, attention, and motor skills, marijuana can affect senses in the same manner. To be considered impaired in Washington State, the blood concentration of THC in a person over the age of 21 is 5 nanograms. Motorcyclists should never be under the influence of marijuana or any other intoxicant while riding, as it is a task that requires alertness, readiness and skill.

Alcohol and the Law

In Washington State, an adult with a blood alcohol concentration (BAC) of 0.08% or above is considered intoxicated. For riders under the age of 21, lower BAC limits of 0.02% apply. A breath or blood test is what typically determines whether you are riding legally or illegally; however, alcohol affects each individual differently, so it is up to law enforcement's discretion whether you are intoxicated or not.

Consequences of Conviction

If you are convicted of riding under the influence of alcohol or drugs, you will receive any of the following penalties:

- **License Suspension** — mandatory suspension for conviction, arrest, or refusal to submit to a breath test.
- **Fines** — severe fines are another aspect of a conviction, usually levied along with a license suspension.
- **Community Service** — serving up to 90 days in a sobriety program or performing tasks such as picking up litter along the highway.
- **Costs** — lawyer fees, fines imposed by the city and county, alcohol evaluations, ignition interlock device (IID), lost time at work, and public transportation costs, for instance.

You are the one who has to make the choice, so choose not to drink and ride. It is your responsibility to create your own safety.

Technology

Technology is an important part of our lives: GPS navigation, cell phones, and headsets that have music and intercom functions all provide benefit, but can also be distractions.

Many motorcycles now have features such as suspension adjustment, riding modes, and traction control that can be electronically adjusted while riding. While the features mentioned here are practical, they can also be a distraction.

Be aware of how technology may distract you from being able to identify traffic conditions and potential hazards.

Body and Emotions

Many distractions come in the form of intense emotions, fatigue, overconfidence, or fear. Health- and age-related conditions such as decreased vision or delayed reaction capabilities can also be considered distractions.

Like athletes in any sport, riders must be both physically and mentally fit to ride safely.

Think about how each of the following situations can impair a rider and possibly increase their risk:

- Any rider who jumps on their bike to “clear their head” may be mentally distracted, which hinders decision making.
- Any rider may become overwhelmed when trying to keep up within a group: they may quickly find themselves reaching beyond their skill, mental, as well as physical abilities.
- Any rider who is mentally or physically exhausted may be too fatigued to identify dangers early.
- Any rider may ride faster or more aggressively than usual when they are experiencing intense negative emotions.

Fear is an impairment that most riders don’t want to admit to, or think about. Intense fear can impair a rider’s mental and physical reaction to a hazard. For example, a rider going too fast in a curve may panic, target fixate on the guard rail, and ride directly into the railing.

Sometimes a rider can be too warm, too cold, or physically uncomfortable to the point of mental or physical impairment.

Conditions such as hypothermia or heat exhaustion can degrade both your mental focus, as well as your physical ability to control the motorcycle.

Wear appropriate safety gear and layer clothing so you can add or remove layers, allowing a safe and comfortable ride through Washington's often unpredictable weather patterns.

Drivers and riders alike may sometimes find their minds wandering, or may even have difficulty staying awake. Always pay close attention to your body AND mind; sometimes you may not need a physical break, but more urgently need a mental break.

Peer Pressure

There are many different forms of peer pressure, whether conscious or subconscious. Peer pressure can be:

- The direct form of your riding partners pushing you to ride beyond your capabilities and skill level.
- A feeling of aggression or tension from occupants in the vehicle next to you at a stop light.
- The thought of a parent, friend, or significant other pressing you to always push your limits.
- Pressure to buy a motorcycle that may not be suitable to your riding abilities.

Most often, peer pressure is felt during group rides. When multiple people with different skill levels ride in a group, you are not only responsible for yourself--every person is responsible for the others in the group as well.

Make sure that you always have a pre-ride discussion with your group about the following:

- How long has each person been riding?
- What is their general comfort level with riding in the group?
- What is each person's skill level, and type of riding experience?

It is your responsibility to honestly address your needs and concerns in a pre-ride discussion. It is your responsibility to clear the thoughts in your head that may be pushing you to ride beyond your experience level.

Make it a point to understand your skills and your motorcycle's capabilities so you can keep your brain focused on the challenges of the road. You must create your own safety by identifying peer pressure and resisting the impulse to react to it.

Riding in Groups

Riding in a group can be a fun and rewarding experience, but group riding can come with its own set of distractions. One of the most common distractions in a group is peer pressure, and it can negatively affect your ability to ride safely within your skill level.

Is maintaining your place in formation keeping you from focusing on potential hazards? From using your street strategies to reduce your risk? Are you choosing the safest lane position? Or are you choosing to be locked into a certain position within the formation?

Gain experience before riding with a group. Don't be pressured into riding above your comfort and skill levels just to keep up with the group. Don't be so distracted by trying to keep formation that you limit your ability to see and be seen. Always allow plenty of space and time to respond to hazards.

Own Your Ride

Never Stop Training

Motorcycling could be considered a sport that requires continuous training. Muscle memory fades quickly when you are not actively training for your sport. Basic rider training is only one tiny block in the knowledge foundation that you need in order to keep yourself alive on the road. Check local motorcycle training schools to see what they offer--since all schools have different course offerings--and take as many courses as you can. You will learn skills that not only help you perfect your sport, but can also save your life.

Wear the Gear

One of the most important things you can do as a motorcyclist is buy good quality gear. Often people do not buy appropriate gear because of the expense, but it can be the difference between a life and death situation in a crash. Compare the cost of quality gear to an emergency hospital bill and you might see that gear is no longer the expensive option. Remember that the minimum requirement in Washington is the use of a helmet and eye protection, but is that

enough to save your life? Think about this: would you let yourself be pulled down the highway at 70 MPH wearing just jeans and a t-shirt? Probably not, but crashing on your motorcycle and sliding across pavement at the same speed is a similar situation. Wear the gear, every ride, every time.

Challenge Peer Pressure

Although you may not consciously notice it, peer pressure is a very real thing. The best thing you can do as a motorcyclist is to resist peer pressure, and challenge it when you recognize it, which can mean the difference between survival and death. Try to think deeply about peer pressure so that you can recognize it when it happens. Remember that peer pressure can come in many different forms, and often sneaks up on you when you least expect it. Do not succumb to the pressure to “prove yourself” to anyone--it can be a matter of life and death in the end.

Ride Sober and Undistracted

Most individuals understand how alcohol and drugs can affect the senses, even if only from a second-hand perspective. You create a losing situation for yourself and possibly someone else when you ride while distracted or intoxicated. Reflect on how long-term injury, death, or harming someone else would affect you and those closest to you. Never drink or use drugs and ride, and never let internal or external distractions interfere with your ability to focus on the road. Remember that your chosen sport requires unhindered concentration and focus.

Create your own Safety

There is only one person in this world that can keep you safe when you are riding your motorcycle: YOU. You are responsible for what happens while you are riding. It is your responsibility to continue training. You are the only one who can make the decision to train for emergency situations. Think about the fire drills you have ever participated in, and how nerve-racking they were in the beginning; but the more you practiced, the easier and more intuitive they became. Practicing for emergency situations on a motorcycle is very similar: you want your response to be instinctual. Think about what “creating your own safety” means to you and practice it.

Always Ride Within your Skill Level

This ties in with all of the other lessons in this book: Take additional training. Do not succumb to peer pressure, and learn to identify it. Make sure to purchase and wear the best gear you can possibly afford. Always ride sober and make sure that you are free of distractions; it only takes a second of distraction to cause a crash. Create your own safety by following the rules of the road, and never expect anyone but yourself to watch out for you.

NOTES

NOTES
